



# Energy Efficiency and Cost Saving Opportunities for Ammonia and Nitrogenous Fertilizer Production

An ENERGY STAR® Guide for Energy & Plant Managers

March 2017



# Energy Efficiency and Cost Saving Opportunities for Ammonia and Nitrogenous Fertilizer Production

## An ENERGY STAR® Guide for Energy and Plant Managers

*Katerina Kermeli, Utrecht University*

*Ernst Worrell, Utrecht University*

*Wina Graus, Utrecht University*

*Mariëlle Corsten, Utrecht University*

March 2017

### Disclaimer

This guide was prepared for the United States Government and is believed to contain correct information. Neither the United States Government nor any agency thereof, nor any persons or organizations involved in its development, makes any warranty, express or implied, or assumes any legal responsibility for the accuracy, completeness, or usefulness of any information, apparatus, product, or process disclosed, or represents that its use would not infringe on privately owned rights. Reference herein to any specific commercial product, process, or service by its trade name, trademark, manufacturer, or otherwise, does not necessarily constitute or imply its endorsement, recommendation, or favoring by the United States Government or any agency thereof, or any persons or organizations involved in its development. The views and opinions of authors expressed herein do not necessarily state or reflect those of the United States Government or any agency thereof.

Development of this guide was funded by the U.S. Environmental Protection Agency. The research embodied in this report was supported through U.S. Environmental Protection Agency Contract No. EP-W-13-009.

The cover photograph is of a fertilizer manufacturing plant.

## Table of Contents

Overview .....	1
Chapter One: Why Energy Management is Good for Your Business .....	2
Chapter Two: Where to Look for Energy Savings .....	3
Chapter Three: Energy Management Programs and Systems .....	8
Chapter Four: Motor Systems .....	13
Chapter Five: Compressed Air Systems .....	19
Chapter Six: Fan Systems .....	27
Chapter Seven: Pump Systems.....	30
Chapter Eight: Steam Systems .....	37
Chapter Nine: Lighting .....	54
Chapter Ten: Building HVAC.....	59
Chapter Eleven: Steam Reforming Process (natural gas).....	66
Chapter Twelve: Shift Conversion Process.....	76
Chapter Thirteen: Gas Refining Process.....	79
Chapter Fourteen: Ammonia Synthesis Process.....	82
Chapter Fifteen: Measures Specific to Urea Production.....	86
Chapter Sixteen: Measures Specific to Ammonium Nitrate Production.....	89
Chapter Seventeen: N <sub>2</sub> O Abatement Measures for Nitric Acid Production .....	91
Chapter Eighteen: Product Finishing Measures .....	98
Conclusion: Why Manage Energy? .....	99
Appendix A: The Ammonia and Nitrogenous Fertilizer Industry.....	101
Appendix B: Energy Consumption by Fertilizer Type.....	116
Appendix C: Energy Use and Intensity in the U.S. Ammonia Industry.....	120
Appendix D: GHG Emissions from the U.S. Nitrogenous Fertilizer Industry .....	122
Appendix E: U.S. Ammonia Production Costs .....	124
Appendix F: U.S. Ammonia Plants .....	125
Appendix G: U.S. Nitric Acid Plants .....	126
Appendix H: CHP Installations at Fertilizer Plants .....	129

**Appendix I: Standards for NEMA Motors ..... 131**  
**Appendix J: Energy Management Program Assessment Matrix..... 132**  
**Appendix K: Teaming Up to Save Energy Checklist ..... 136**  
**Appendix L: Support Programs for Industrial Energy Efficiency Improvement ..... 138**  
**Glossary ..... 142**  
**References ..... 145**



## Overview

This Guide provides information to identify cost-effective practices and technologies to increase energy efficiency in the nitrogenous fertilizer industry. This research provides information on potential energy efficiency opportunities for ammonia, urea and ammonium nitrate plants and on potential opportunities to decrease the N<sub>2</sub>O emissions in nitric acid plants, a powerful greenhouse gas with a high global warming potential. This Guide focuses on the most important systems, processes, and practices that account for the bulk of energy consumption. The information found here will help energy and plant managers identify energy reduction opportunities in their facilities as well as improve the quality of nitrogenous fertilizer operations. For additional information on nitrogenous fertilizer and associated processes and their energy consumption, please consult Appendices A and B of this Guide.

For ammonia producers, natural gas costs account for the bulk of production costs, estimated at 72-85% of overall costs. Energy waste is found in all plants, and improving energy efficiency goes right to the bottom line. Following the procedures outlined in this guide will reduce your energy costs (and dollars spent) per ton<sup>1</sup> of fertilizer produced while improving your environmental reputation as well as image in the community. This Guide is organized as follows:

- **Chapter One** - the value of energy management in a nitrogenous fertilizer production facility,
- **Chapter Two** – information on energy costs and energy efficiency opportunities in ammonia production,
- **Chapters Three through Eighteen** - step-by-step best practices to save energy and reduce costs in ammonia, urea, ammonium nitrate production and product finishing, and on how to reduce N<sub>2</sub>O emissions in nitric acid production.
- **Appendices** – explanation on how energy is used in the industry and in various processes and plant types along with a variety of assessments, standards and guidelines for additional reference.

Prior to implementation, assess the economics, actual energy savings and improved product quality that each measure found in this Guide can provide to individual plants.

EPA offers tools and resources to help companies build strategic energy management programs that span all operations. Begin online at [www.energystar.gov/industry](http://www.energystar.gov/industry) with “Get Started with ENERGY STAR.” Helpful resources can be found throughout the site to support an organization-wide energy program at no charge to your company. Further, EPA invites companies that operate nitrogenous fertilizer plants to participate in the ENERGY STAR Focus on Energy Efficiency in Nitrogenous Fertilizers, a group of fertilizer producing companies that work together to share best energy management practices and to build unique and helpful energy management tools specific to the nitrogenous fertilizer industry. If you have questions or need assistance with building a corporate energy program, contact [energystrategy@energystar.gov](mailto:energystrategy@energystar.gov).

---

<sup>1</sup> In this Guide, weight is reported in short tons and is simply referred to as tons.

## Chapter One: Why Energy Management is Good for Your Business

Energy management programs control long-term energy risks and build stability into the business by reducing energy costs by 3% to 10% annually. Energy management also reduces waste and emissions that can be costly to control.<sup>2</sup>

Well-run energy programs attract new talent to your company, improve its reputation within communities, and create value for the corporate brand.

Nitrogenous fertilizer producers have additional reasons to pay attention to energy efficiency. Natural gas use can account for up to 85% of operating costs, which are highly dependent on natural gas prices. To withstand future price fluctuations and remain competitive, new plants should use energy-efficient state-of-the-art technologies while older and more inefficient plants should assess retrofitting opportunities. Energy efficiency improvements will reduce the energy cost per unit of product – a practical method for growing market share.

To see financial returns from energy management, regularly assess energy performance and implement steps to increase energy efficiency in areas where you will get the most efficiency for dollars spent. Turn your company into a high-performance organization that improves your bottom line and environmental reputation by

- Actively managing energy;
- Adopting a structured approach;
- Establishing policies and procedures that will achieve long-term results;
- Enlisting senior management's support;
- Allocating staff and resources to energy management;
- Establishing goals;
- Developing management structures that empower staff to address energy efficiency issues directly;
- Identifying and implementing energy savings; and,
- Building a culture of continuous improvement.

### DID YOU KNOW?

**Energy savings from improving energy efficiency go directly to a company's bottom line! Many companies can save 3-10% annually.**

---

<sup>2</sup> See EPA's report "Energy Strategy for the Road Ahead" at [www.energystar.gov/energystrategy](http://www.energystar.gov/energystrategy).

## Chapter Two: Where to Look for Energy Savings

By looking strategically at how energy is used throughout the ammonia and nitrogenous fertilizers manufacturing processes, energy managers can better assess where energy efficiency efforts will be effective. Reviewing energy use trends can save time by focusing management efforts on areas and processes where the greatest efficiency can be generated and also save on operational costs. This chapter looks at where energy is consumed as well as trends in energy consumption.

Due to the recent strong decline in natural gas prices, the U.S. ammonia industry is going through a revival, with capacity expansions, mothballed plants put back into production, and even new plants being planned. Yet, fertilizer manufacturing is energy intensive. Per the U.S. Census, in 2012, American nitrogenous fertilizer plants spent \$334 million on fuels and \$175 million on electricity (U.S. Census, 2014). In 2010, \$1.8 billion was spent on energy, including feedstocks (EIA, 2013).

### DID YOU KNOW?

**If you don't manage energy, your business is giving money away to the utility.**

How is this money spent?

- Over 80% of the energy consumed in the nitrogenous fertilizer industry is for ammonia production. The next highest energy consuming process is urea production.
- Most of the fuel for ammonia production is consumed in the primary reformer (about 78%) and the remaining in auxiliary boilers. Natural gas use for energy purposes accounts for 66% of overall energy expenses (excluding feedstock use).
- The highest cost for ammonia producers is natural gas. Depending on the size of the ammonia plant and the price of natural gas, natural gas expenses for energy and feedstock purposes account for 72-85% of overall production costs.
- In the U.S., almost all ammonia plants use natural gas as feedstock. According to the 2010 Manufacturing Energy Consumption Survey (MECS) (EIA, 2013), in 2010, 99% of the feedstock use in the U.S. nitrogenous fertilizer industry was natural gas.

### Energy Consumption within the Ammonia and Nitrogenous Fertilizer Industry

The energy intensity of the U.S. ammonia industry cannot be directly calculated since the energy consumption reported in MECS concerns the nitrogenous fertilizer industry as a whole. Per the MECS (EIA, 2013), in 2010, the nitrogenous fertilizer industry consumed 154 TBtu (148 PJ) in fuels and 12 TBtu (13 PJ) in electricity. The USGS (2012) reports that, in 2010, 7.8 million tons of nitrogen was used to produce ammonia for fertilizer purposes; that is about 9.6 million tons of ammonia (NH<sub>3</sub>). Hence, fuel use is

estimated at 13.7 MMBtu/ton<sup>3</sup> ammonia (14.5 GJ/tonne ammonia), excluding feedstocks. In 2010, 204 TBtu (196 PJ) of natural gas was consumed as feedstock (EIA, 2013), equal to 21.3 MMBtu/ton ammonia (22.6 GJ/tonne ammonia). Overall fuel use in the U.S. ammonia industry is estimated at 35 MMBtu/ton ammonia (37 GJ/tonne ammonia). The wide adoption of the best practice technology (BPT) in the U.S. ammonia industry has the potential to decrease energy use by 14%.

So where are the best opportunities to save energy and reduce costs given the trends in overall energy consumption?

First, plants use energy for equipment such as motors, pumps, and compressors.

These important components require regular maintenance, good operation, and replacement when necessary. Thus, a critical element of plant energy management involves the efficient control of cross-cutting equipment that powers the production process of a plant. A second and equally important area is the proper and efficient operation of the process. Process optimization and ensuring the use of the most efficient technology is key to realizing energy savings in a plant's operation. Finally, throughout a plant, there are many processes that run simultaneously. Process integration may offer further opportunities.

Energy efficiency improvements in this industry are more likely to be completed when natural gas prices are high because natural gas costs, for energy and feedstock purposes, account for 72-85% of overall production costs (TFI, 2005).

For information on energy use in specific types of plants in nitrogenous fertilizer production, please see Appendix B. For information on energy use in U.S. ammonia plants, please see Appendix C.

## Energy Efficiency Opportunities

Many of the energy efficiency measures discussed in this Guide require either a limited investment or none at all. Common plant systems are those that are found in most manufacturing plants regardless of the industry.

Energy efficiency measures are described below in Table 1 to Table 6 by end-use category. Chapters Three through Eighteen are organized according to these measures. Generally, each chapter begins with a description of the topic, a checklist for quick reference, and a description of best practices starting with the easier-to-implement measures.

If reading this guide online, you may click on the chapter titles listed in Table 1 to Table 6 to be taken directly to these chapters. Refer back to these tables as a reference tool for your energy management program.

---

<sup>3</sup> The heating value of a fuel can be expressed in lower (or net) heating value (LHV) and higher (or gross) heating value (HHV). The difference is the condensation heat of water vapor generated in the combustion process, which is included in the HHV. LHV is commonly used in international statistics and in Europe, while HHV is used in the U.S. and Canada. In this guide, unless otherwise indicated, values are given in HHV. In parenthesis, energy use is reported in GJ/tonne LHV.

### DID YOU KNOW?

**If the energy required per unit of product is reduced, you can grow your market share!**



Table 1. Summary of general energy efficiency measures.

<b>Chapter 3: Energy Management Programs and Systems</b>	
Build an energy management program	Principles for developing energy management programs and systems
ENERGY STAR tools and resources	
<b>Chapter 4: Motor Systems</b>	
Create a motor management plan	Select and purchase motors strategically
Perform ongoing maintenance	Properly sized motors
Automate motors	Use adjustable speed drives
Correct power factor	Minimize voltage imbalances
Use soft starters	
<b>Chapter 5: Compressed Air Systems</b>	
Maintain systems	Monitor effectively
Reduce leaks	Turn off unnecessary compressed air
Modify system instead of increasing pressure	Replace compressed air with other energy sources
Minimize pressure drops	Maximize allowable pressure dew point at air intake
Improve load management	Reduce inlet air temperature
Use compressor controls	Properly size pipe diameters
Recover heat for water preheating	Use natural gas-driven air compressors
<b>Chapter 6: Fan Systems</b>	
Maintain systems properly	Properly size fans
Use adjustable speed drives and improved controls	Install high efficiency belts
Repair duct leaks	
<b>Chapter 7: Pump Systems</b>	
Maintain pump systems	Monitor pump system
Minimize pump demand	Install controls
Install high efficiency pumps	Properly size pumps
Use multiple pumps for variable loads	Install adjustable speed drives
Trim impellers	Avoid throttling valves
Replace belt drives	Properly size piping
Use precision casting, surface coatings or polishing	Sealings
Maintain proper seals	Reduce leakage through clearance reduction
<b>Chapter 8: Steam Systems</b>	
Process integration	Total site pinch analysis
<i>Steam Supply - Boiler</i>	
Match steam demand	Control boiler allocation
Install boiler flue shut-off dampers	Perform maintenance
Improve insulation	Reduce fouling
Optimize boiler blowdown rate	Reduce excessive flue gas
Reduce excess air	Monitor flue gas
Install turbulators	Use an economizer
Recover heat from boiler blowdown	Reduce standby losses
Recover condensate	
<i>Combined Heat and Power (CHP)</i>	
Gas turbines	Steam turbines
Reciprocating engines	Waste heat-to-power
<i>Steam distribution</i>	
Shut off excess distribution lines	Properly size pipes
Insulate	Check and monitor steam traps

Use thermostatic steam traps	Shut steam traps
Reduce distribution pipe leaks	Recover low pressure waste steam through vapor recompression
Recover flash steam	
<b>Chapter 9: Lighting</b>	
Turn off lights in unoccupied areas	Use occupancy sensors and other lighting controls
Upgrade exit signs	Replace magnetic ballasts with electronic ballasts
Replace T-12 tubes with T-8 tubes	Reduce lighting system voltage
Replace mercury lights with metal halide or high pressure sodium	Replace metal halide HID with high-intensity fluorescent lights
Use daylighting	Use LED lighting
<b>Chapter 10: HVAC Systems</b>	
Employ an energy-efficient system design	Consider recommissioning before replacing
Install energy monitoring and control systems	Adjust non-production setback temperatures
Repair leaking ducts	Consider variable air volume systems
Install adjustable speed drives	Consider heat recovery systems
Modify your fans	Use ventilation fans
Install efficient exhaust fans	Add building insulation
Employ solar air heating	Modify building reflection
Install low-emittance windows	

Table 2. Summary of energy efficiency measures specific to ammonia production.

<b>Chapter 11: Steam Reforming Process (natural gas)</b>	
Install adiabatic pre-reformer	Retrofit with heat exchanger reformer
Heat exchange autothermal reforming	Recover reformer flue gas heat
Increase mixed feed preheat temperature	Insulate reformer furnace
Increase reformer operating pressure	Lower reformer S/C ratio
Shift reformer duty	Use improved catalyst designs for primary reforming
Use improved catalyst designs for secondary reforming	Use improved materials for reformer tubes
Improve design of secondary reformer burner	Use improved arch seals at the primary reformer
Install a feed-gas saturator	Install natural gas expansion turbine
<b>Chapter 12: Shift Conversion Process</b>	
Isothermal CO converter	Axial-radial flow converter
Use improved catalysts in shift process	Apply low pressure drop shift converter design
Use low temperature shift (LTS) guard with waste heat recovery	Consider the Selectoxo process for final purification
<b>Chapter 13: Gas Refining Process</b>	
High pressure water power recovery turbine	Use enhanced CO <sub>2</sub> removal solvents
Recover heat from solvent regeneration in CO <sub>2</sub> removal section	Pressure swing adsorption for product purification
Use two stage regeneration in CO <sub>2</sub> removal system	
<b>Chapter 14: Ammonia Synthesis Process</b>	
Implement indirect cooling	Low pressure drop synthesis reactor in combination with smaller particle size catalysts
Use low pressure ammonia synthesis catalysts	Recover waste heat from synthesis gas compressor
Install a purge gas recovery unit (hydrogen recovery unit)	Synthesis gas molecular sieve dryer and direct synthesis converter feed
Improve the ammonia synthesis configuration	

Table 3. Summary of energy efficiency measures specific to urea production.

<b>Chapter 15: Urea Production</b>	
Adopt stripping	Use isobaric double recycling (IDR)
NH <sub>3</sub> washing from inerts	Redirect fines to the concentrated urea solution
Employ heat integration in stripping plants	Adopt new carbamate condenser design
Use high efficiency reactor trays	

Table 4. Summary of energy efficiency measures specific to ammonium nitrate production.

<b>Chapter 16: Ammonium Nitrate Production</b>	
Optimize the neutralization step	Recover residual heat for cooling
Optimize energy use and steam export	Recycle nitrogen compounds

Table 5. Summary of N<sub>2</sub>O reduction measures for nitric acid plants

<b>Chapter 17: Nitric Acid Production</b>	
<i>Primary N<sub>2</sub>O controls</i>	
Oxidation catalyst and campaign length	Optimize ammonia oxidation
Use improved and alternative oxidation catalysts	
<i>Secondary N<sub>2</sub>O controls</i>	
Homogeneous N <sub>2</sub> O decomposition by extension of the reactor chamber	Catalytic N <sub>2</sub> O decomposition in the reaction chamber
<i>Tertiary N<sub>2</sub>O controls</i>	
Thermal N <sub>2</sub> O decomposition	Catalytic N <sub>2</sub> O decomposition in tail gases
Non-selective catalytic reduction of NO <sub>x</sub> and N <sub>2</sub> O in tail gases	Combined N <sub>2</sub> O and NO <sub>x</sub> abatement with hydrocarbons

Table 6. Summary of energy efficiency measures applicable to all fertilizer plants.

<b>Chapter 18: Product Finishing</b>	
Install plate bank product cooler	Recycle warm air

## Chapter Three: Energy Management Programs and Systems

### In this chapter:

Build an energy management program	Principles for developing energy management programs and systems
ENERGY STAR tools and resources	

Building an energy management program is the first step to increase energy efficiency and save money. EPA has seen companies that successfully manage energy achieve consistent savings over time. Further, a corporate culture that encourages energy efficiency enhances the reputation of a company as one that cares for the environment.

### Energy Savings Checklist: Energy Management

Energy Management Checklist	✓
Understand your energy use.	
Set goals.	
Assess plants for energy savings.	
Set a plan for improvement.	
Develop good operations and maintenance practices.	
Track and benchmark energy use.	
Encourage behavior changes and engage employees.	
Recognize and reward energy achievements.	

### Best Practices for Energy Management Programs and Systems

- **Build an energy management program.** By constructing an energy management program, you can assess your energy consumption, motivate energy teams to manage energy across all facilities, and continuously benchmark and improve your company's energy performance.
- **Apply the principles for developing energy management programs and systems.** ENERGY STAR Guidelines for Energy Management can inform the development of your program through key actions for success.
- **Use the ENERGY STAR tools and resources.** ENERGY STAR offers a variety of assessment tools, guides, communication materials, and other resources to support your energy program.

## Build an energy management program.

Successful energy management goes beyond installing energy-efficient equipment. Build a solid foundation for a company-wide energy program by following the [ENERGY STAR Guidelines for Energy Management](#) and make energy one of the top items managed by your business.

Next, institute sound energy management practices into your program, including: (1) energy assessments, (2) energy teams and (3) energy tracking, measurement, and benchmarking.

### 1) Assess the energy efficiency of your plant(s).

Assessing the energy used in plants helps determine how, how much and where energy is consumed. This information enables the identification of steps to improve the facility's energy efficiency and save money. Assessments may be focused on the whole site or specific systems and processes.

Assessments may be conducted by company staff, the local electric utility, contractors, or government programs:

- Staff teams. If company employees perform the plant assessment, include staff from various departments across the facility. This brings together a spectrum of experience and knowledge on the plant and its processes. Facilities of any size can successfully use this method. ENERGY STAR provides guidance for a type of assessment that uses employee teams, the Energy Treasure Hunt (see [www.energystar.gov/treasurehunt](http://www.energystar.gov/treasurehunt) for more information).
- Electric utility program. Local utility companies work with their industrial clients to achieve energy savings in existing facilities and in the design of new facilities. Check with your local electric utility to see what assistance it provides. Utilities sometimes offer specific programs for improving plant systems such as lighting or motors.
- Federal government programs. The U.S. DOE supports plant assessments through the [Industrial Assessment Center \(IAC\)](#) program. IACs are designed to help small- and medium-size enterprises. Universities that participate in the program offer free assessments performed by students.

### DID YOU KNOW?

**The cost of paying one employee to lead an energy management program should be more than recovered by potential energy savings!**

### 2) Build an energy team.

Establishing an energy team is an important part of making a commitment to energy management because a team can accomplish much more than a single person can accomplish alone. The energy team is responsible for planning, implementing, benchmarking, monitoring, and evaluating the organizational energy management program. The team's duties also include delivering training, communicating results, and providing recognition.



The ENERGY STAR [Teaming Up to Save Energy](#) guide is designed to help organizations develop effective energy teams. The guide provides advice, checklists and examples for starting an energy program, organizing an energy team, building capacity, sustaining the team, and maintaining momentum (see also Appendix K).

### 3) Monitor your energy systems.

Every company should compile, track, and benchmark energy data. Reliable energy data helps you manage energy and interpret energy efficiency trends over time so you can take corrective action when necessary.

Here are a few reasons it's important to monitor energy:

- Identifies increased use and costs that could be caused by operational inefficiencies.
- Supports participation in emergency demand response programs where utility companies provide financial incentives to customers who reduce their energy loads during peak demand times.
- Provides data useful for corporate greenhouse gas accounting initiatives.

Data on energy use can be found in utility bills, fuel purchase receipts, and from self-installed meters. Using an energy monitoring system is ideal. It requires little or no up-front capital and can result in immediate savings.

Energy monitoring systems include submeters at key areas in a plant to strategically track and manage energy. Submetering production departments can provide improved metrics and enables quick pinpointing of areas where energy problems may exist. The meters' data should be managed with a data management tool; a simple spreadsheet may be sufficient or tailored software is also available.

In its simplest form, an energy monitoring system should be based on:

- Monthly utility billing and energy-use data for the past 12 to 24 months.
- Monthly production figures.

A simple spreadsheet may be used to plot graphs for visually understanding the relationship between energy use and production as well as to identify any trends. Graphs can be made for fuel and electricity separately, as well as for total energy use (showing both in the same units, such as megajoules or British thermal units) and costs. For example:

- Graphs of energy use and production over time.
- Graphs of energy costs and production over time.
- Graphs of energy use on vertical axis against production on horizontal axis.
- Graphs of energy use divided by production (showing specific energy consumption).

**CASE STUDIES:** Installation of advanced process control software at an ammonia plant in Australia improved productivity by approximately 5.5 tons per day (tpd) of extra ammonia. This saved 28 GBtu/year (30 TJ/year) and 1,650 tons CO<sub>2</sub>/year. The payback period was less than 6 months (Australian Government, 2009).

A 1,500 tpd ammonia plant in India implemented an advanced process control upgrade in 2003, reducing the steam/carbon ratio by 3% from 3.59 to 3.48, excess oxygen in the flue gas by 20%, and the recycle stream of the naphtha desulfurization section by 95%. The specific energy consumption of the ammonia plant decreased by 0.6% (Honeywell, unknown date).

Often the analysis will show periods of good performance and poor performance. This information helps with setting targets for energy consumption based on expected production volumes. Tracking energy use by entering new data and re-evaluating it regularly will help identify problems and improve energy savings.

The ENERGY STAR [Energy Tracking Tool](#) is available at no cost to companies and sites for use in tracking energy.

### Principles for developing energy management programs and systems.

An organization-wide energy management program is the best way to save energy and money. It doesn't matter whether your company is big or small...any company can do it! Simply apply the following basic principles:

- 1) Make energy a priority.

*Everyone* in the company, *especially senior management*, must recognize that reducing energy use is an important business objective that must be a part of decision making.

- 2) Commit to save energy.

Every level of the organization must support the commitment to improve energy efficiency.

- 3) Assign responsibility.

Someone must be assigned responsibility for managing energy across the company. The annual pay for a corporate energy manager is more than covered by the costs of the energy you will save. An energy team with roles assigned to each member is a practical way to share the load across all facilities.

- 4) Look beyond your initial costs.

You get what you pay for. Energy-efficient equipment and products may cost more initially but the long-term savings will surpass the initial costs.

5) Make energy management a continuous process.

**CASE STUDIES:** Implementation of advanced process control in an ammonia plant in Antwerp, Belgium, showed that even when plant operation has already been optimized, there is still room for improvement in plant profitability. More than €400,000 per year were saved, resulting in a payback of less than one year (ThyssenKrupp, unknown date).

The advanced process control system implemented at the ammonia plant in Ludwigshafen, Germany, realized a 2.5% increase in production. Total payback time for the project was less than 6 months (Honeywell, 2012).

### ENERGY STAR tools and resources.

EPA offers tools and resources to help companies build a strategic energy management program that spans all operations. Begin online at [www.energystar.gov/industry](http://www.energystar.gov/industry) with “Get Started with ENERGY STAR.” Helpful resources can be found throughout the site, which is designed to walk you through the main steps of building an organization-wide energy program at no charge to your company.

To assess how well your company manages energy currently, use the ENERGY STAR [Energy Program Assessment Matrix](#), located within the ENERGY STAR Guidelines for Energy Management and Appendix J of this guide.

EPA works with thousands of companies to identify the basics of an effective energy management program by using the [ENERGY STAR Guidelines for Energy Management](#). If your company has questions or needs assistance with building a corporate energy program, contact [energystrategy@energystar.gov](mailto:energystrategy@energystar.gov).

## Chapter Four: Motor Systems

In this chapter:	
Create a motor management plan	Select and purchase motors strategically
Perform ongoing maintenance	Properly size motors
Automate motors	Employ motor labeling
Correct power factor	Use adjustable speed drives
Use soft starters	Minimize voltage imbalances

Considering energy efficiency improvements to motor from a “systems approach” analyzes both the energy supply and energy demand sides of motor systems as well as how these interact to optimize total system performance, which includes not only energy use but also system uptime and productivity.

A systems approach involves the following steps.

1. Locate and identify all applications of motors in a facility.
2. Document the conditions and specifications of each motor in a current systems inventory.
3. Assess the needs and the actual use of the motor systems to determine if motors are properly sized and how well each meets the needs of its driven equipment.
4. Collect information on potential repairs and upgrades to the motor systems, including the economic costs and benefits of implementing repairs and upgrades to inform decisions.
5. Monitor performance of the upgraded motor systems to determine the actual costs savings when upgrades are completed (SCE, 2003).

### Systems Approach

**A systems approach strives to optimize the energy efficiency of entire motor systems (i.e., motors, drives, driven equipment such as pumps, fans, and compressors, and controls), not just the energy efficiency of motors as single components.**

The motor system energy efficiency measures below reflect important aspects of this systems approach, including matching motor speeds and loads, proper motor sizing, and upgrading system components.

### Energy Savings Checklist: Motor Systems

To achieve energy efficiency improvements to motor systems, it is important to address the energy efficiency of the entire motor system. Use the checklist below to find new ways to save energy and money with motor system improvements.

**Replacing a motor with a more efficient one can achieve energy savings of 5-10%.**

Motor Checklist	✓
Are motors properly sized?	
Are motors maintained?	
Can adjustable or variable speed drives be installed?	
Can older, less efficient motors be replaced?	
Do you have a motor management program?	

## Best Practices for Energy-Efficient Motor Systems

- **Create a motor management plan.** A motor management plan can help companies realize energy savings and ensure that system failures are handled quickly and cost-effectively.
- **Select and purchase motors strategically.** Considering life cycle costs and motor efficiency can reduce motor system life-cycle costs.
- **Perform ongoing maintenance.** Motor maintenance prolongs motor life and helps foresee motor failure.
- **Properly size motors.** Replacing oversized motors with properly sized motors saves U.S. industry, on average, 1.2% of total motor system electricity consumption.
- **Employ motor labeling.** Motors not in use should be identified and powered off.
- **Automate motors.** Running motors only when needed saves energy and does not significantly affect the lifetime of the motor.
- **Use Adjustable Speed Drives (ASD's).** Adjustable-speed drives better match speed to load requirements for motor operations and ensure that motor energy use is optimized to a given application.
- **Correct power factor.** Reducing the magnitude of reactive power in the system can reduce power consumption.
- **Minimize voltage imbalances.** Monitor voltages and minimize imbalances to increase of motor efficiency.
- **Use soft starters.** Soft starters reduce power use during motor start up.



### Create a motor management plan.

A motor management plan is an essential part of a plant's energy management strategy. A motor management plan helps companies realize long-term motor system energy savings and ensures that motor failures are handled quickly and cost effectively. The Motor Decisions Matter<sup>SM</sup> Campaign suggests the following key activities for a sound motor management plan (MDM, 2012):

- 1) Create a motor survey and tracking program.
- 2) Develop guidelines for proactive repair/replace decisions.
- 3) Prepare for motor failure by creating a spare motor inventory.
- 4) Develop of a purchasing specification.
- 5) Develop of a repair specification.
- 6) Develop and implement a predictive and preventive maintenance program.

It is important to develop a motor purchasing policy and to stock a selection of preferred premium efficiency motors to replace existing motors at failure. Otherwise, it is likely and common that the motors will be replaced by less efficient alternatives.

The Motor Decisions Matter<sup>SM</sup> Campaign's *Motor Planning Kit* contains further details on each of these elements (MDM, 2012).

### Select and purchase motors strategically.

Several factors are important when selecting a motor, including motor speed, horsepower, enclosure type, temperature rating, efficiency level, and quality of power supply. When selecting and purchasing a motor, it is also critical to consider the life-cycle costs of that motor rather than just the price of its initial purchase and installation. Life cycle costing (LCC) is an accounting framework that enables calculation of the total costs of ownership for different investment options, leading to a sound evaluation of competing options in motor purchasing and repair or replacement decisions. A specific LCC guide has been developed for pump systems (Fenning et al., 2001), which also provides an introduction to LCC for motor systems.

#### Motor Selection

**Up to 95% of a motor's costs can be attributed to the energy it consumes over its lifetime, while only around 5% of a motor's costs are typically attributed to its purchase, installation, and maintenance (MDM, 2012).**

The selection of energy-efficient motors is an important strategy for reducing motor system life cycle costs. Energy-efficient motors reduce energy losses through improved design, better materials, tighter tolerances, and improved manufacturing techniques. With proper installation, energy-efficient motors can also run cooler (which may help reduce facility heating loads) and have higher service factors, longer bearing life, longer insulation life, and less vibration.

To be considered energy-efficient in the United States, a motor must meet performance criteria published by the National Electrical Manufacturers Association (NEMA). See Appendix I for more information.

The choice of installing a premium efficiency motor depends on motor operating conditions and the life cycle costs associated with the investment. In general, premium efficiency motors are most economically attractive when replacing motors with annual operation exceeding 2,000 hours/year. However, software tools such as MotorMaster+ (see Appendix L) can help identify attractive applications of premium efficiency motors based on the specific conditions at a given plant.

Sometimes, even replacing an operating motor with a premium efficiency model may have a low payback period. According to data from the Copper Development Association, the upgrade to high-efficiency motors, as compared to motors that achieve the minimum efficiency as specified by EPACT, can have paybacks of less than 15 months for 50 hp motors (CDA, 2001). *Given the quick payback time, it usually makes sense to buy the most efficient motor available* (U.S. DOE and CAC, 2003).

NEMA and other organizations have created the Motor Decisions Matter<sup>SM</sup> campaign to help industrial and commercial customers evaluate their motor repair and replacement options, promote cost-effective applications of NEMA Premium<sup>R</sup> motors and “best practice” repair, and support the development of motor management plans before motors fail.

In some cases, it may be cost-effective to rewind an existing energy-efficient motor, instead of purchasing a new motor. As a rule of thumb, when rewinding costs exceed 60% of the costs of a new motor, purchasing the new motor may be a better choice (MDM, 2012). When rewinding a motor, it is important to choose a motor service center that follows best practice motor rewinding standards in order to minimize potential efficiency losses. An ANSI-approved recommended best practice standard has been offered by the Electric Apparatus Service Association (EASA) for the repair and rewinding of motors (EASA, 2006). When best rewinding practices are implemented, efficiency losses are typically less than 0.5 to 1% (EASA, 2003). However, poor quality rewinds may result in larger efficiency losses. It is therefore important to inquire whether the motor service center follows EASA best practice standards (EASA, 2006).

### Perform ongoing maintenance.

Motor maintenance prolongs motor life and helps anticipate motor failure. Motor maintenance measures can be categorized as either preventative or predictive. Preventative measures, which prevent unexpected downtime of motors, include electrical consideration, voltage imbalance minimization, load consideration, and motor ventilation, alignment, and lubrication. The purpose of predictive motor maintenance is to observe ongoing motor temperature, vibration, and other operating data to identify when it becomes necessary to overhaul or replace a motor before failure occurs (Barnish et al., 1997). *The savings associated with an ongoing motor maintenance program are significant, and could range from 2 to 30% of total motor system energy use* (Efficiency Partnership, 2004).

### Properly size motors.

Inappropriately sized motors cause unnecessary energy losses. Where peak loads on driven equipment can be reduced, motor size can also be reduced. Replacing oversized motors with properly sized motors saves, on average for U.S. industry, 1.2% of total motor system electricity consumption (Xenergy, 1998). Higher savings can often be realized for smaller motors and individual motor systems.

Properly sizing a motor depends on the following: load on the motor, operating efficiency of the motor at that load point, the full-load speed of the motor to be replaced, and the full-load speed of the replacement motor. The U.S. DOE provides a range of technical assistance, [tip sheets](#) and software tools for decision making on [motor systems](#).

### Employ motor labeling.

Motors not in use should be powered off. This can be done through automated systems (see below), or motors can be labeled to show the typical use, e.g. continuous operation (365/24/7), production days, during production, or when an operator is present. Toyota and Bodine Casting have successfully introduced (colored) labeling for motor systems in a number of plants.

### Automate motors.

Motors should only run when needed. Though some people are concerned that frequent motor start-ups will negatively affect a motor's lifetime, as long as the frequency of motor start-ups is not excessive, the lifetime will not be significantly affected (U.S. DOE, 2008a). NEMA (2001) gives the maximum number of allowable motor start-ups per hour and the duration of rest time between start-ups, for various horsepower motors and synchronous speed ratings.

### Use adjustable speed drives (ASDs).<sup>4</sup>

Adjustable-speed drives better match speed to load requirements for motor operations, and therefore ensure that motor energy use is optimized to a given application. Adjustable-speed drive systems are offered by many suppliers and are available worldwide. Worrell et al. (1997) provide an overview of savings achieved with ASDs in a wide array of applications; typical energy savings are shown to vary between 7 and 60%.

#### Motor Automation

**A 10% reduction in motor operating time can save more energy than replacing a conventional motor with a NEMA Premium® efficiency motor (U.S. DOE, 2008a). Therefore, automatic shutdown of motors that would otherwise be left idling can reduce energy costs without requiring high investment.**

---

<sup>4</sup> Several terms are used in practice to describe a motor system that permits a mechanical load to be driven at variable speeds, including adjustable speed drives (ASDs), variable speed drives (VSDs), adjustable frequency drives (AFDs), and variable frequency drives (VFDs). The term ASD is used throughout this Guide for consistency.

### **Correct power factor.**

Inductive loads like transformers, electric motors, and HID lighting may cause a low power factor, which may result in increased power consumption and increased electricity costs. The power factor can be corrected by minimizing idling of electric motors (a motor that is turned off consumes no energy), replacing motors with premium efficiency motors (see above), and installing capacitors in the AC circuit to reduce the magnitude of reactive power in the system.

### **Minimize voltage imbalances.**

A voltage unbalance degrades the performance and shortens the life of three-phase motors. A voltage unbalance causes a current unbalance, which will result in torque pulsations, increased vibration and mechanical stress, increased losses, and motor overheating, which can reduce the life of a motor's winding insulation. Voltage unbalances may be caused by faulty operation of power factor correction equipment, an unbalanced transformer bank, or an open circuit. A rule of thumb is that the voltage unbalance at the motor terminals should not exceed 1%. Even a 1% unbalance will reduce motor efficiency at part load operation while a 2.5% unbalance will reduce motor efficiency at full load operation.

See <http://www.energy.gov/eere/amo/downloads/eliminate-voltage-unbalance>.

For a 100 hp motor operating 8,000 hours per year, a correction of the voltage unbalance from 2.5 to 1% will result in electricity savings of 9,500 kWh or almost \$500 at an electricity rate of \$0.05/kWh (U.S. DOE, 2005a).

By regularly monitoring the voltages at the motor terminal and through regular thermographic inspections of motors, voltage unbalances may be identified. It is also recommended to verify that single-phase loads are uniformly distributed and to install ground fault indicators as required. Another indicator that a voltage unbalance may be a problem is 120 Hz vibration, which should prompt an immediate check of voltage balance (U.S. DOE, 2005a). The typical payback period for voltage controller installation on lightly loaded motors in the United States is about 2 years (IAC, 2015).

### **Use soft starters.**

Soft starters are special devices, which allow the gradual speed acceleration of the motor, and limit the electrical stresses associated with motor start-up (U.S. DOE, 2003b). With the use of soft starters, power use during motor start-up can be reduced.

## Chapter Five: Compressed Air Systems

In this chapter:	
Maintain systems	Monitor effectively
Reduce leaks	Turn off unnecessary compressed air
Modify system instead of increasing pressure	Replace compressed air with other energy sources
Minimize pressure drops	Maximize allowable pressure dew point at air intake
Improve load management	Reduce inlet air temperature
Use compressor controls	Properly size pipe diameters
Recover heat for water preheating	Use natural gas-driven air compressors

Compressed air systems consist of a supply side, which includes compressors and air treatment, and a demand side, which includes distribution and storage systems and end-use equipment. According to the U.S. DOE, a properly managed supply side will result in clean, dry, stable air being delivered at the appropriate pressure in a dependable, cost-effective manner. A properly managed demand side minimizes waste air and uses compressed air for appropriate applications (U.S. DOE, 2003b).

### Energy Savings Checklist: Compressed Air

*Compressed air is often the most expensive form of energy available in a plant because of its poor efficiency.* However, there are several possible steps to improve the energy efficiency of compressed air. Use the checklist below to find new ways to save energy and costs.

Compressed Air Checklist	Potential Gains	✓
Reduce system header pressure.	A 2-3 psi discharge pressure reduction results in a 1% energy decrease.	
Is a compressed air program in place to minimize air leaks?	Typically 15-25% of air usage is air leaks, if no compressed air program is in place.	
Are the pumps and fans sequenced with VFD?	If there is no sequencing in place, there is potential for a 15-25% energy reduction.	
Is waste heat being captured?	Every 100 CFM of rejected heat equates to 50,000 Btus of available heat.	
Are all air compressors on a master controller?	Use of master system controller results in energy savings of 10-20%.	
Can the temperature of air intake be reduced?	For every 5-10 degree reduction, there is a resulting 1% energy savings.	
Have you sized your system properly?		



## Best Practices for Energy-Efficient Compressed Air

- **Maintain systems.** Proper maintenance can reduce leakage, pressure variability, and increase efficiency.
- **Monitor effectively.** Use measures such as temperature and pressure gauges and flow meters to save energy and money.
- **Reduce leaks.** Leak maintenance can reduce leak rates to less than 10%.
- **Turn off unnecessary compressed air.** Save energy by ensuring no air is flowing to unused parts of the system.
- **Modify system instead of increasing pressure.** Modify equipment instead of raising the pressure of the entire system to reduce cost.
- **Replace compressed air with other energy sources.** Other sources of energy can be more economical and more efficient than compressed air.
- **Minimize pressure drops.** Use a systems approach to minimize pressure drop, reduce energy consumption and increase system performance.
- **Maximize allowable pressure dew point at air intake.** Use a dryer with a floating dew point to maximize efficiency.
- **Improve load management.** Use two-stage compressors or multiple smaller compressors to save energy. Large compressors consume more electricity when they are unloaded than do multiple smaller compressors with similar overall capacity.
- **Reduce inlet air temperature.** Reduce air temperature to reduce energy used by the compressor and increase compressor capacity.
- **Use compressor controls.** Compressor controls shut off unneeded compressors and can save up to 12% in energy costs annually.
- **Properly size pipe diameters.** Increasing pipe diameters can minimize pressure losses and leaks, reduce system-operating pressures, and reduce energy consumption by 3%.
- **Recover heat for water preheating.** A heat recovery unit can recover thermal energy and save up to 20% of the energy used in compressed air systems annually for space heating.
- **Use natural gas-driven air compressors.** Gas-driven compressors can have lower operating costs.

### Pressure Reductions

**As a rule of thumb, every 2-3 pound reduction in header pressure yields one percent in energy savings.**

## Maintain systems.

Poor maintenance lowers compression efficiency and increases air leakage or pressure variability, leading to increased operating temperatures, poor moisture control, and excessive contamination. Improved maintenance reduces these problems and saves energy. Proper maintenance includes the following (U.S. DOE and CAC, 2003; Scales and McCulloch, 2007):

- *Keep the compressor and intercooling surfaces clean and foul-free.* Blocked filters increase pressure drop. Inspect and periodically clean filters to reduce pressure drop. Use filters with just a 1 psig pressure drop over 10 years. The payback period for filter cleaning is usually under 2 years (Ingersoll-Rand, 2001). Fixing improperly operating filters will also prevent contaminants from entering tools and causing them to wear out prematurely. Generally, when pressure drop exceeds 2 to 3 psig, replace the particulate and lubricant removal elements. Inspect all systems at least annually. Consider adding filters in parallel that decrease air velocity and, therefore, decrease air pressure drop. A 2% reduction of annual energy consumption in compressed air systems is projected when filters are replaced frequently (Radgen and Blaustein, 2001).
- *Keep motors properly lubricated and cleaned.* Poor motor cooling can increase motor temperature and winding resistance, shorten motor life and increase energy consumption. Compressor lubricant should be changed every 2 to 18 months and checked to make sure it is at the proper level. In addition to energy savings, this can help avoid corrosion and degradation of the system.
- *Inspect drain traps* periodically to ensure they are not stuck in the open or closed positions and are clean. Some users leave automatic condensate traps partially open at all times to allow for constant draining. This practice wastes substantial energy and has no role in a properly maintained system. Instead, install simple pressure driven valves. Malfunctioning traps should be cleaned and repaired, and not left open. Some auto drains, such as float switch or electronic drains, do not waste air. Inspecting and maintaining drains typically has a payback of less than 2 years (U.S. DOE, 2004a).
- *Maintain the coolers* on the compressor so that the dryer gets the lowest possible inlet temperature (U.S. DOE and CAC, 2003).
- *Check belts for wear* and adjust them. A good practice is to adjust after every 400 hours of operation.
- *Replace air lubricant separators* according to specifications or sooner. Rotary screw compressors generally start with their air lubricant separators having a 2 to 3 psid pressure drop at full load. When this increases to 10 psid, change the separator (U.S. DOE and CAC, 2003).
- *Check water cooling systems* for water quality (pH and total dissolved solids), flow, and temperature. Clean and replace filters and heat exchangers per manufacturer's specifications.
- *Check for excess pressure, duration, and volume* in applications that require compressed air. Applications not requiring maximum system pressure should be regulated, either by production line sectioning or by pressure regulators on the equipment itself. Using more pressure than required wastes energy and can shorten equipment life and add maintenance costs.

### Monitor effectively.

Effective monitoring systems save energy and money and typically include the following (CADET, 1997b):

- Pressure gauges on each receiver or main branch line and differential gauges across dryers, filters, etc.
- Temperature gauges across the compressor and its cooling system to detect fouling and blockages.
- Flow meters to measure the quantity of air used.
- Dew point temperature gauges to monitor the effectiveness of air dryers.
- Kilowatt-hour meters and hours run meters on the compressor drive.
- Checking of compressed air distribution systems after equipment has been reconfigured to be sure that no air is flowing to unused equipment or to obsolete parts of the compressed air distribution system.
- Checking for flow restrictions of any type in a system, such as an obstruction or roughness, which can unnecessarily raise system operating pressures. As a rule of thumb, every 2 psi pressure rise resulting from resistance to flow can increase compressor energy use by 1% (U.S. DOE and CAC, 2003). The highest pressure drops are usually found at the points of use, including undersized or leaking hoses, tubes, disconnects, filters, regulators, valves, nozzles and lubricators (demand side), as well as air/lubricant separators, after-coolers, moisture separators, dryers and filters.
- Checking for compressed air use outside production hours.

### Reduce leaks.

A typical plant that has not been well maintained will likely have a leak rate equal to 20 to 50% of total compressed air production capacity (U.S. DOE and CAC, 2003). Leak maintenance can reduce this number to less than 10%. Overall, a 20% reduction of annual energy consumption in compressed air systems is projected for fixing leaks (Radgen and Blaustein, 2001).

#### Leak Reductions

**The payback period for leak reduction efforts is generally shorter than four months.**

Estimations of leaks vary with the size of the hole in the pipes or equipment. A compressor operating 2,500 hours per year at 87 psi with a leak diameter of 0.02 inches ( $\frac{1}{2}$  mm) is estimated to lose 250 kWh per year; 0.04 inches (1 mm) to lose 1,100 kWh per year; 0.08 inches (2 mm) to lose 4,500 kWh per year; and 0.16 in. (4 mm) to lose 11,250 kWh per year (CADET, 1997b).

In addition to increased energy consumption, leaks can make air tools less efficient and adversely affect production, shorten the life of equipment, lead to additional maintenance requirements and increase unscheduled downtime. In the worst case, leaks can add unnecessary compressor capacity.

**Continuing Programs**  
**Leak detection and correction programs should be ongoing efforts.**

The most common areas for leaks are couplings, hoses, tubes, fittings, pressure regulators, open condensate traps and shut-off valves, pipe joints, disconnects, and thread sealants. A simple way to detect leaks is to apply soapy water to suspect areas. Another simple way is a bleed down test (Bayne, 2011). In a bleed down test the plant air system is brought to full pressure and then shut down. By recording the system pressure while compressed air is not used anywhere in the plant, any pressure losses can be attributed to existing leaks. The best way to detect leaks is to use an ultrasonic acoustic detector, which can recognize the high frequency hissing sounds associated with air leaks. After identification, leaks should be tracked, repaired, and verified. Leak detection and correction programs should be ongoing efforts.

### **Turn off unnecessary compressed air.**

Equipment that is no longer using compressed air should have the air turned off completely using a simple solenoid valve. Compressed air distribution systems should be checked when equipment has been reconfigured to ensure that no air is flowing to unused equipment or to obsolete parts of the compressed air distribution system.

### **Modify system instead of increasing pressure.**

For individual applications that require a higher pressure, instead of raising the operating pressure of the whole system, special equipment modifications should be considered, such as employing a booster, increasing a cylinder bore, changing gear ratios, or changing operation to off peak hours.

### **Replace compressed air with other energy sources.**

Many operations can be accomplished more economically and efficiently using energy sources other than compressed air (U.S. DOE 2004b, U.S. DOE, 2004c). Various options exist to replace compressed air use, including:

- Cool electrical cabinets with air conditioning fans instead of compressed air vortex tubes.
- Create a vacuum with a vacuum pump instead of compressed air venturi methods.
- Cool, aspirate, agitate, mix, or inflate packaging with blowers.
- Clean parts or remove debris with brushes, blowers, or vacuum pump systems.
- Move parts with blowers, electric actuators, or hydraulics.
- Special case tools or actuators: electric motors should be considered because they are more efficient than using compressed air (Howe and Scales, 1995). However, it has been reported that

motors can have less precision, shorter lives, and lack safety compared to compressed air. In these cases, using compressed air may be a better choice.

Based on numerous industrial case studies, the average payback period for replacing compressed air with other applications is about 1 year (IAC, 2015).

### **Minimize pressure drops.**

Excessive pressure drop results in poor system performance and excessive energy consumption. Flow restrictions of any type in a system, such as an obstruction or roughness, result in higher operating pressures than needed. Resistance to flow increases the drive energy on positive displacement compressors by 1% of connected power for each 2 psi of differential (U.S. DOE and CAC, 2003). The highest pressure drops are usually found at the points of use, including undersized or leaking hoses, tubes, disconnects, filters, regulators, valves, nozzles, and lubricators (demand side), as well as air/lubricant separators on lubricated rotary compressors and after-coolers, moisture separators, dryers, and filters (supply side).

Minimizing pressure drop requires a systems approach in design and maintenance. Air treatment components should be selected with the lowest possible pressure drop at specified maximum operating conditions and best performance. Manufacturers' recommendations for maintenance should be followed, particularly in air filtering and drying equipment, which can have damaging moisture effects like pipe corrosion. Finally, minimize the distance the air travels through the distribution.

### **Maximize allowable pressure dew point at air intake.**

Choose the dryer that has the maximum allowable pressure dew point, and best efficiency. A rule of thumb is desiccant dryers consume 7 to 14% of the total energy of the compressor, whereas refrigerated dryers consume 1 to 2% as much energy as the compressor (Ingersoll-Rand, 2001). Consider using a dryer with a floating dew point.

### **Improve load management.**

Because of the large amount of energy consumed by compressors, whether in full operation or not, partial load operation should be avoided. For example, unloaded rotary screw compressors still consume 15 to 35% of full-load power while delivering no useful work (U.S. DOE and CAC, 2003).

Air receivers can be employed near high demand areas to provide a supply buffer to meet short-term demand spikes that can exceed normal compressor capacity. In this way, the number of required online compressors may be reduced. Multi-stage compressors theoretically operate more efficiently than single-stage compressors. Multi-stage compressors save energy by cooling the air between stages, reducing the volume and work required to compress the air. Replacing single-stage compressors with two-stage compressors typically provides a payback period of two years or less (Ingersoll-Rand, 2001). Using multiple smaller compressors instead of one large compressor can save energy as well. Large compressors consume more electricity when they are unloaded than do multiple smaller compressors with similar overall capacity. An analysis of U.S. case studies shows an average payback period for optimally sizing compressors of about 1.5 years (IAC, 2015).



### Reduce inlet air temperature.

Reducing the inlet air temperature reduces energy used by the compressor. In many plants, it is possible to reduce inlet air temperature to the compressor by drawing fresh air from outside the building. Importing fresh air can have paybacks of 2 to 5 years (CADET, 1997b). As a rule of thumb, each 5°F (3°C) will save 1% compressor energy use (CADET, 1997b; Parekh, 2000). In addition to energy savings, compressor capacity is increased when cold air from outside is used. Industrial case studies have found an average payback period for importing outside air of less than 1 year (IAC, 2015), but costs can vary significantly depending on facility layout.

### Use compressor controls.

The primary objectives of compressor control strategies are to shut off unneeded compressors and to delay bringing on additional compressors until needed. Energy savings for sophisticated compressor controls have been reported at around 12% annually (Radgen and Blaustein, 2001). An excellent review of compressor controls can be found in *Compressed Air Challenge® Best Practices for Compressed Air Systems* (Second Edition) (Scales and McCulloch, 2007). Common control strategies for compressed air systems include:

- *Start/stop (on/off) controls*, in which the compressor motor is turned on or off in response to the discharge pressure of the machine. Start/stop controls can be used for applications with very low duty cycles and are applicable to reciprocating or rotary screw compressors. The typical payback for start/stop controls is one to two years (CADET, 1997b).
- *Load/unload controls*, or constant speed controls, which allow the motor to run continuously but unloads the compressor when the discharge pressure is adequate. In most cases, unloaded rotary screw compressors still consume 15 to 35% of full-load power while delivering no useful work (U.S. DOE and CAC, 2003). Hence, load/unload controls can be inefficient.
- *Modulating or throttling controls*, which allow the output of a compressor to be varied to meet flow requirements by closing down the inlet valve and restricting inlet air to the compressor. Throttling controls are applied to centrifugal and rotary screw compressors.
- *Single master sequencing system controls*, which take individual compressor capacities on-line and off-line in response to monitored system pressure demand and shut down any compressors running unnecessarily. System controls for multiple compressors typically offer a higher efficiency than individual compressor controls.
- *Multi-master controls*, which are the latest technology in compressed air system control. Multi-master controls are capable of handling four or more compressors and provide both individual compressor control and system regulation by means of a network of individual controllers (Martin et al., 2000). The controllers share information, allowing the system to respond more quickly and accurately to demand changes. One controller acts as the lead, regulating the whole operation. This strategy allows each compressor to function at a level that produces the most efficient overall operation. The result is a highly controlled system pressure that can be reduced close to the minimum level required (U.S. DOE and CAC, 2003). According to Nadel et al. (1992), such advanced compressor controls are expected to deliver energy savings of about 3.5% where applied.

In addition to energy savings, the application of controls can sometimes eliminate the need for some existing compressors, allowing extra compressors to be sold or kept for backup. Alternatively, capacity can be expanded without the purchase of additional compressors. Reduced operating pressures will also help reduce system maintenance requirements (U.S. DOE and CAC, 2003).

### **Properly size pipe diameters.**

Increasing pipe diameters to the greatest size that is feasible and economical for a compressed air system can help to minimize pressure losses and leaks, which reduces system operating pressures and leads to energy savings. Increasing pipe diameters typically reduces compressed air system energy consumption by 3% (Radgen and Blaustein, 2001). Further savings can be realized by ensuring other system components (e.g., filters, fittings, and hoses) are properly sized.

### **Recover heat for water preheating.**

As much as 80 to 93% of the electrical energy used by an industrial air compressor is converted into heat. In many cases, a heat recovery unit can recover 50 to 90% of this available thermal energy for space heating, industrial process heating, water heating, makeup air heating, boiler makeup water preheating, industrial drying, industrial cleaning processes, heat pumps, laundries or preheating aspirated air for oil burners (Parekh, 2000). It's been estimated that approximately 50,000 Btu/hour of energy is available for each 100 cfm of capacity (at full load) (U.S. DOE and CAC, 2003). Paybacks are typically less than one year (Galitsky et al., 2005).

Heat recovery for space heating is not as common with water-cooled compressors because an extra stage of heat exchange is required and the temperature of the available heat is lower. However, with large water cooled compressors, recovery efficiencies of 50 to 60% are typical (U.S. DOE and CAC, 2003). Implementing this measure saves up to 20% of the energy used in compressed air systems annually for space heating (Radgen and Blaustein, 2001).

### **Use natural gas-driven air compressors.**

Gas engine-driven air compressors can replace electric compressors with some advantages and disadvantages. Gas engine-driven compressors are more expensive and can have higher maintenance costs, but may have lower overall operating costs depending on the relative prices of electricity and gas. Variable-speed capability is standard for gas-fired compressors, offering a high efficiency over a wide range of loads. Heat can be recovered from the engine jacket and exhaust system. However, gas engine-driven compressors have some drawbacks: they need more maintenance, have a shorter useful life, and sustain a greater likelihood of downtime.

## Chapter Six: Fan Systems

In this chapter:	
Maintain systems properly	Properly size fans
Use adjustable speed drives and improved controls	Install high efficiency belts
Repair duct leaks	

Considerable opportunities exist to upgrade the performance and improve the energy efficiency of fan systems. For fans in particular, concerns about failure or underperformance have led to many fans being oversized for their particular application (U.S. DOE, 2003b). Oversized fans do not operate at optimal efficiency and therefore waste energy. However, the efficiencies of fan systems vary considerably across impeller types.

### Best Practices for Energy-Efficient Fan Systems

- **Maintain systems properly.** A proper maintenance program can improve system performance, reduce downtime, minimize repair costs, and increase system reliability.
- **Properly size fans.** Properly sized fans have lower capital, maintenance, and energy costs.
- **Use adjustable speed drives (ASD's) and improved controls.** Retrofitting fans with ASD's can save up to 49% in energy costs.
- **Install high efficiency belts (cog belts).** Replace standard V-belts with cog belts to save energy and money.
- **Repair duct leaks.** Installing duct insulation and performing regular duct inspection and maintenance reduce system leaks and save significant amounts of energy.

### Maintain systems properly.

As for most energy using systems, a proper maintenance program for fans can improve system performance, reduce downtime, minimize repair costs, and increase system reliability. The U.S. DOE recommends establishing a regular maintenance program for fan systems, with intervals based on manufacturer recommendations and experience with fans in similar applications (U.S. DOE, 2003b). Additionally, the U.S. DOE recommends the following important elements of an effective fan system maintenance program (U.S. DOE, 2003b):

- **Inspect Belts.** In belt-driven fans, belts are usually the most maintenance-intensive part of the fan assembly. Belts wear over time and can lose tension, reducing their ability to transmit power efficiently. Regularly inspect and tighten belts, especially for large fans given the potential size of the power loss.

- *Clean fans.* Many fans experience a significant loss in energy efficiency due to the build-up of contaminants on blade surfaces. Build-up can create imbalance problems that reduces performance and contributes to premature wear of system components. Fans that operate in particulate-laden or high-moisture airstreams are particularly vulnerable and should be cleaned regularly.
- *Inspect and repair leaks.* Leakage in a fan duct system decreases the amount of air that is delivered to the desired end use, which can significantly reduce the efficiency of the fan system. Inspect ductwork on a regular basis and repair leaks as soon as possible. In systems with inaccessible ductwork, use temporary pressurization equipment to determine if the integrity of the system is adequate.
- *Lubricate bearings.* Worn bearings can lead to premature fan failure, as well as create unsatisfactory noise levels. Monitor and frequently lubricate fan bearings based on manufacturer recommendations.
- *Replace motors.* Eventually, all fan motors will wear and will require repair or replacement. The decision to repair or replace a fan motor should be based on a life cycle cost analysis, as described in the motor systems section.

### Properly size fans.

Conservative engineering practices often result in the installation of fans that exceed system requirements. Such oversized fans lead to higher capital costs, maintenance costs, and energy costs than fans that are properly sized for the job (U.S. DOE, 2003b). However, other options may be more cost effective than replacing an oversized fan with a smaller fan (U.S. DOE, 2002). Other options include (U.S. DOE, 2003b):

- Decreasing fan speed using different motor and fan sheave sizes (may require downsizing the motor).
- Installing an ASD or multiple-speed motor (see below).
- Using an axial fan with controllable pitch blades.

### Use adjustable speed drives (ASDs) and improved controls.

Significant energy savings can be achieved by installing adjustable speed drives on fans. Savings may vary between 14 and 49% when retrofitting fans with ASDs (U.S. DOE, 2002).

### Install high efficiency belts (cog belts).

Belts make up a variable, but significant portion of the fan system in many plants. It is estimated that about half of the fan systems use standard V-belts, and about two-thirds of these could be replaced by more efficient cog belts (U.S. DOE, 2002). Standard V-belts tend to stretch, slip, bend and compress, which lead to a loss of efficiency. Replacing standard V-belts with cog belts can save energy and money, even as a retrofit.

Cog belts run cooler, last longer, require less maintenance and have an efficiency that is about 2% higher than standard V-belts. Typical payback periods will vary from less than one year to three years.

### **Repair duct leaks.**

Duct leakage can waste significant amounts of energy in fan and ventilation systems. Measures for reducing duct leakage include installing duct insulation and performing regular duct inspection and maintenance, including ongoing leak detection and repair. For example, per studies by Lawrence Berkeley National Laboratory, repairing duct leaks in industrial and commercial spaces could reduce HVAC energy consumption by up to 30% (Galitsky et al., 2005).

Because system leakage can have a significant impact on fan system operating costs, the U.S. DOE recommends considering the type of duct, the tightness and quality of the fittings, joint assembly techniques, and the sealing requirements for duct installation as part of the fan system design process as proactive leak prevention measures (U.S. DOE, 2003b).

## Chapter Seven: Pump Systems

In this chapter:	
Maintain pump systems	Monitor pump system
Minimize pump demand	Install controls
Install high efficiency pumps	Properly size pumps
Use multiple pumps for variable loads	Install adjustable speed drives
Trim impellers	Avoid throttling valves
Replace belt drives	Properly size piping
Use precision casting, surface coatings or polishing	Reduce leakage through clearance reduction
Maintain proper seals	

Pumping systems consist of a pump, a driver, piping systems, and controls (such as ASDs or throttles). There are two main ways to increase pump system efficiency, aside from reducing use. These are reducing the friction in dynamic pump systems (not applicable to static or "lifting" systems) or upgrading/adjusting the system so that it draws closer to the best efficiency point on the pump curve (Hovstadius, 2007). Correct sizing of pipes, surface coating or polishing and ASDs, for example, may reduce the friction loss, increasing energy efficiency. Correctly sizing the pump and choosing the most efficient pump for the applicable system will push the system closer to the best efficiency point on the pump curve. Furthermore, pump systems are part of motor systems, and, thus, the general "systems approach" to energy efficiency described in Chapter 4 for motors applies to pump systems as well.<sup>5</sup>

### Energy Savings Checklist: Pump Systems

Energy is typically the most significant cost associated with the life cycle of a pump system, accounting for up to 95% of the lifetime costs of the pump. Use the checklist below to find new ways to save energy and money.

Pump Systems Checklist	✓
Can you minimize pump demand by better matching pump requirements to end use loads?	
Is a control system in place to automatically shut off pumps when demand is reduced?	
Is older, inefficient technology being used?	
Are pumps properly sized, including the use of multiple pumps for variable loads?	
Are adjustable-speed drives (ASDs) being used?	
Is the impeller properly sized or trimmed?	
Replace v-belt with energy-efficient belt (i.e. cog belt).	

<sup>5</sup> The U.S. DOE's Industrial Technologies Program provides a variety of resources for improving the efficiency of industrial pumps, which can be consulted for more detailed information on many of the measures presented in this chapter. The U.S. DOE's *Improving Pumping System Performance: A Sourcebook for Industry* is a particularly helpful resource (U.S. DOE, 2006a). For a collection of tips, tools, and industrial case studies on industrial pump efficiency, visit the DOE's website at: <http://energy.gov/eere/amo/pump-systems>.

## Opportunities for Energy Efficiency

Initial costs are only a fraction of the lifetime cost of a pump system. Energy expenditures, and sometimes operations and maintenance expenditures, are much more important. In general, for a pump system with a lifetime of 20 years, the initial capital expense of the pump and motor make up merely 2.5% of the total costs of ownership (Best Practice Programme, 1998). Depending on the pump application, energy outlays may comprise about 95% of the lifetime expenses of the pump. Hence, the initial choice of a pump system should be highly dependent on energy cost considerations rather than on initial costs such as the price of the pump and related parts.

Optimization of the design of a new pumping system should focus on optimizing the lifecycle expenditures. Hodgson and Walters (2002) discuss software developed for this purpose and several case studies in which they show large reductions in energy use and lifetime costs of a complete pumping system. Typically, such an approach will lead to energy savings of 10-17%.

## Best Practices for Energy-Efficient Pump Systems

- **Maintain pump systems.** A maintenance program keeps pumps running optimally and can save up to 7% in energy.
- **Monitor pump system.** Monitoring and maintenance can detect problems and determine solutions to increase the efficiency of the system.
- **Minimize pump demand.** Reducing demand through holding tanks and elimination of bypass loops can save up to 20% in energy.
- **Install controls.** Control systems increase efficiency of pump systems and significantly reduce costs.
- **Install high efficiency pumps.** New high efficiency pumps can result in up to 10% in energy savings.
- **Properly size pumps.** Replacing oversized pumps with properly sized ones can reduce electricity by up to 25%.
- **Use multiple pumps for variable loads.** Using multiple pumps in parallel is a cost-effective and energy-efficient method for pump systems with variable loads.
- **Install adjustable speed drives (ASDs).** Including modulation features like ASD's can save an estimated 20 to 50% of pump energy consumption.
- **Trim impellers.** Reducing an impeller's diameter reduces energy added to the pump system.
- **Avoid throttling valves.** Pump demand reduction, controls, impeller trimming, and multiple pump strategies (all previously discussed in this section) are more energy-efficient flow management strategies than throttling valves.
- **Replace belt drives.** Replacing belt drives with cog belts saves energy and money.



- **Properly size piping.** Increasing pipe diameters as part of a system retrofit reduces pumping energy.
- **Use precision casting, surface coatings, or polishing.** Using castings, coatings, or polishing reduces pump surface roughness and increases energy efficiency.
- **Maintain proper seals.** Use gas barrier seals, balanced seals, and no-contact labyrinth seals to decrease seal losses.
- **Reduce leakage through clearance reduction.** Use hard construction materials such as chromium steel to reduce the wear rate of the clearance between the impeller suction and pressure sides.

### Maintain pump systems.

Inadequate maintenance can lower pump system efficiency, cause pumps to wear out more quickly, and increase pumping energy costs. A pump system maintenance program will help to avoid these problems by keeping pumps running optimally. Furthermore, improved pump system maintenance can lead to energy savings from 2 to 7% (U.S. DOE, 2002). A solid pump system maintenance program will generally include the following tasks (U.S. DOE, 2006a; U.S. DOE, 2002):

- Replacement of worn impellers, especially in caustic or semi-solid applications.
- Inspection and repair of bearings.
- Replacement of bearing lubrication on an annual or semiannual basis.
- Inspection and replacement of packing seals. Allowable leakage from packing seals is usually between 2 to 60 drops per minute.
- Inspection and replacement of mechanical seals. Allowable leakage is typically 1 to 4 drops per minute.
- Replacement of wear ring and impeller. Pump efficiency degrades by 1 to 6% for impellers less than the maximum diameter and with increased wear ring clearances.
- Check pump/motor alignment.
- Inspection of motor condition, including the motor winding insulation.

### Monitor pump system.

Monitoring in conjunction with operations and maintenance can be used to detect problems and determine solutions to create a more efficient system. Monitoring can determine clearances that need adjustment, indicate blockage, impeller damage, inadequate suction, operation outside of preferences, clogged or gas-filled pumps or pipes, or worn out pumps. Monitoring should include:

- Specific energy consumption, i.e. electricity use/flow rate (Hovstadius, 2007).
- Wear monitoring.
- Vibration analyses.
- Pressure and flow monitoring.
- Current or power monitoring.
- Differential head and temperature rise across the pump (also known as thermodynamic monitoring).
- Distribution system inspection for scaling or contaminant build-up.

### **Minimize pump demand.**

An important component of the systems approach is to minimize pump demand by better matching pump requirements to end use loads. Two effective strategies for reducing pump demand are the use of holding tanks and the elimination of bypass loops. Holding tanks can be used to equalize pump flows over a production cycle, which can allow for more efficient operation of pumps at reduced speeds and lead to energy savings of 10 to 20% (U.S. DOE, 2002). Holding tanks can also reduce the need to add pump capacity. The elimination of bypass loops and other unnecessary flows can result in energy savings of 10 to 20% (U.S. DOE, 2002). Other effective strategies for reducing pump demand include lowering process static pressures, minimizing elevation rises in the piping system, and lowering spray nozzle velocities.

### **Install controls.**

Control systems can increase the energy efficiency of a pump system by shutting off pumps automatically when demand is reduced, or, alternatively, by putting pumps on standby at reduced loads until demand increases.

### **Install high efficiency pumps.**

It has been estimated that up to 16% of pumps in use in U.S. industry are more than 20 years old (U.S. DOE, 2002). Considering that a pump's efficiency may degrade by 10 to 25% over the course of its life, replacement of aging pumps can lead to significant energy savings. The installation of newer, higher efficiency pumps typically results in energy savings of 2 to 10% (Elliott, 1994).

Several high efficiency pumps are available for specific pressure head and flow rate capacity requirements. Choosing the right pump often saves both operating and capital costs. For a given duty, selecting a pump that runs at the highest speed suitable for the application will generally result in a more efficient selection as well as the lowest initial cost (U.S. DOE, 2001a).

### Properly size pumps.

Pumps that are oversized for an application consume more energy than is necessary (see also “avoiding throttling valves” below). Replacing oversized pumps with pumps that are properly sized can often reduce the electricity use of a pumping system by 15 to 25% (U.S. DOE, 2002). Where peak loads can be reduced through improvements to pump system design or operation (e.g., via the use of holding tanks), pump size can also be reduced. If a pump is dramatically oversized, often its speed can be reduced with gear or belt drives or a slower speed motor. The typical payback period for the above strategies can be less than one year (Galitsky et al., 2005a).

### Use multiple pumps for variable loads.

The use of multiple pumps installed in parallel can be a cost-effective and energy-efficient solution for pump systems with variable loads. Parallel pumps offer redundancy and increased reliability, and can often reduce pump system electricity use by 10 to 30% for highly variable loads (U.S. DOE, 2002). Parallel pump arrangements often consist of a large pump, which operates during periods of peak demand, and a small pump (or “pony” pump), which operates under normal, more steady-state conditions. Because the pony pump is sized for normal system operation, this configuration operates more efficiently than a system that relies on a large pump to handle loads far below its optimum capacity.

### Install adjustable speed drives (ASDs).

ASDs better match speed to load requirements for pumps whereas for motors, energy use is approximately proportional to the cube of the flow rate<sup>6</sup>. Hence, small reductions in flow rates that are proportional to pump speed may yield large energy savings for friction dominated pump systems. However, in static head dominated systems, the energy use might increase when using ASDs if the speed is turned down too much. New installations may result in short payback periods. In addition, the installation of ASDs improves overall productivity, control and product quality, and reduces wear on equipment, thereby lowering future maintenance costs.

According to inventory data collected by Xenergy (1998), 82% of pumps in U.S. industry have no load modulation feature (or ASD). Similar to being able to adjust load in motor systems, including modulation features with pumps is estimated to save between 20 and 50% of pump energy consumption, at relatively short payback periods, depending on application, pump size, load and load variation (Xenergy, 1998; Best Practice Programme, 1996). The savings depend strongly on the system curve. As a rough rule of thumb, unless the pump curves are exceptionally flat, a 10% regulation in flow should produce pump savings of 20%, and 20% regulation should produce savings of 40% (Best Practice Programme, 1996).

---

<sup>6</sup> This equation applies to dynamic systems only. Systems that solely consist of lifting (static head systems) will accrue no benefits from ASDs (but often will become more inefficient) because pump efficiency usually drops when speed is reduced in such systems. A careful choice of operating points can to some extent overcome this problem. Similarly, systems with more static head will accrue fewer benefits than systems that are largely dynamic (friction) systems. More careful calculations must be performed to determine actual benefits, if any, for these systems.

### Trim impellers.

Impeller trimming refers to the process of reducing an impeller's diameter via machining, which will reduce the energy added by the pump to the system fluid. Per the U.S. DOE (2006b), one should consider trimming an impeller when any of the following conditions occur:

- Many system bypass valves are open, indicating that excess flow is available to system equipment.
- Excessive throttling is needed to control flow through the system or process.
- High levels of noise or vibration indicate excessive flow.
- A pump is operating far from its design point.

Trimming an impeller is slightly less effective than buying a smaller impeller from the pump manufacturer, but can be useful when an impeller at the next smaller available size would be too small for the given pump load. The energy savings associated with impeller trimming are dependent upon pump power, system flow, and system head, and are roughly proportional to the cube of the diameter reduction (U.S. DOE, 2006a). An additional benefit of impeller trimming is a decrease in pump operating and maintenance costs. Care must be taken when an impeller is trimmed or the speed is changed so that the new operating point does not end up in an area where the pump efficiency is low.

### Avoid throttling valves.

Throttling valves and bypass loops are indications of oversized pumps as well as the inability of the pump system design to accommodate load variations efficiently, and should always be avoided (Tutterow et al., 2000). Pump demand reduction, controls, impeller trimming, and multiple pump strategies (all previously discussed in this section) should always be more energy-efficient flow management strategies than throttling valves. Several industrial case studies from the IAC database suggest that the replacement of throttling systems with ASDs results in payback periods of only 1.6 to 2.3 years (IAC, 2015).

### Replace belt drives.

Most pumps are directly driven. However, inventory data suggests 4% of pumps have V-belt drives (Xenergy, 1998). Standard V-belts tend to stretch, slip, bend and compress, which leads to a loss of efficiency. Replacing standard V-belts with cog belts can save energy and money, even as a retrofit. It is better to replace the pump by a direct driven system, resulting in increased savings of up to 8% and payback periods as short as 6 months (Studebaker, 2007).

### Properly size piping.

Pipes that are too small for the required flow velocity can significantly increase the amount of energy required for pumping, in much the same way that drinking a beverage through a small straw requires a greater amount of suction. Where possible, pipe diameters can be increased to reduce pumping energy requirements, but the energy savings due to increased pipe diameters must be balanced with increased costs for piping system components. A lifecycle costing approach is recommended to ensure positive economic benefits when energy savings, increased material costs, and installation costs are considered.

Increasing pipe diameters will likely only be cost effective during greater pump system retrofit projects. The U.S. DOE estimates typical industrial energy savings in the 5 to 20% range (U.S. DOE, 2002).

### **Use precision castings, surface coatings or polishing.**

The use of castings, coatings, or polishing reduces pump surface roughness that in turn increases energy efficiency. It may also help maintain efficiency over time. This is more effective on smaller pumps. One case study in the steel industry analyzed the investment in surface coating on the mill supply pumps (350 kW pumps). It was determined that the additional cost of coating, \$1200, would be paid back in 5 months by energy savings of \$2700 (or 36 MWh, 2%) per year (Hydraulic Institute and Europump, 2001). Energy savings for coating pump surfaces are estimated to be 2 to 3% over uncoated pumps (Best Practice Programme, 1998).

### **Maintain proper sealings.**

Seal failure accounts for up to 70% of pump failures in many applications (Hydraulic Institute and Europump, 2001). The sealing arrangements on pumps will contribute to the power absorbed. Often the use of gas barrier seals, balanced seals, and no-contacting labyrinth seals decrease seal losses.

### **Reduce leakage through clearance reduction.**

Internal leakage losses are a result of differential pressure across the clearance between the impeller suction and pressure sides. The larger the clearance, the greater is the internal leakage causing inefficiencies. The normal clearance in new pumps ranges from 0.014 to 0.04 inches. (0.35 to 1.0 mm) (Hydraulic Institute and Europump, 2001). With wider clearances, the leakage increases almost linearly with the clearance. For example, a clearance of 0.2 inches (5 mm) decreases the efficiency by 7 to 15% in closed impellers and by 10 to 22% in semi-open impellers. Abrasive liquids and slurries, even rainwater, can affect the pump efficiency. Using very hard construction materials (such as high chromium steel) can reduce the wear rate.

## Chapter Eight: Steam Systems

In this chapter:	
Integrate the process	Perform total site pinch analysis
<i>Steam Supply – Boiler</i>	
Match steam demand	Control boiler allocation
Install boiler flue shut-off dampers	Perform maintenance
Improve insulation	Reduce fouling
Optimize boiler blowdown rate	Reduce excessive flue gas
Reduce excess air	Monitor flue gas
Install turbulators	Use an economizer
Recover heat from boiler blowdown	Reduce standby losses
Recover condensate	
<i>Steam Supply – Combined Heat and Power (CHP)</i>	
Gas turbines	Steam turbines
Reciprocating engines	Waste heat-to-power
<i>Steam distribution</i>	
Shut off excess distribution lines	Properly size pipes
Insulate	Check and monitor steam traps
Use thermostatic steam traps	Shut off steam traps
Reduce distribution pipe leaks	Recover low pressure waste steam through vapor recompression
Recover flash steam	

While the exact size and use of a modern steam system varies greatly, there is an overall pattern that steam systems follow (see Figure 1). Treated cold feed water is fed to the boiler, where it is heated to form steam. Chemical treatment of the feed water is required to remove impurities, because impurities would otherwise collect on the boiler tube walls. Even though the feed water has been treated, some impurities remain and can build up in the boiler water. Thus, water is periodically drained from the bottom of the boiler in a process known as blow down. The generated steam travels along the pipes of the distribution system to get to the process where the heat will be used. Sometimes the steam is passed through a pressure reduction valve if the process requires lower pressure steam. In steam transport, the steam cools down, and some of it is condensed. The condensate is removed by a steam trap that allows condensate to pass through, but blocks the passage of steam.

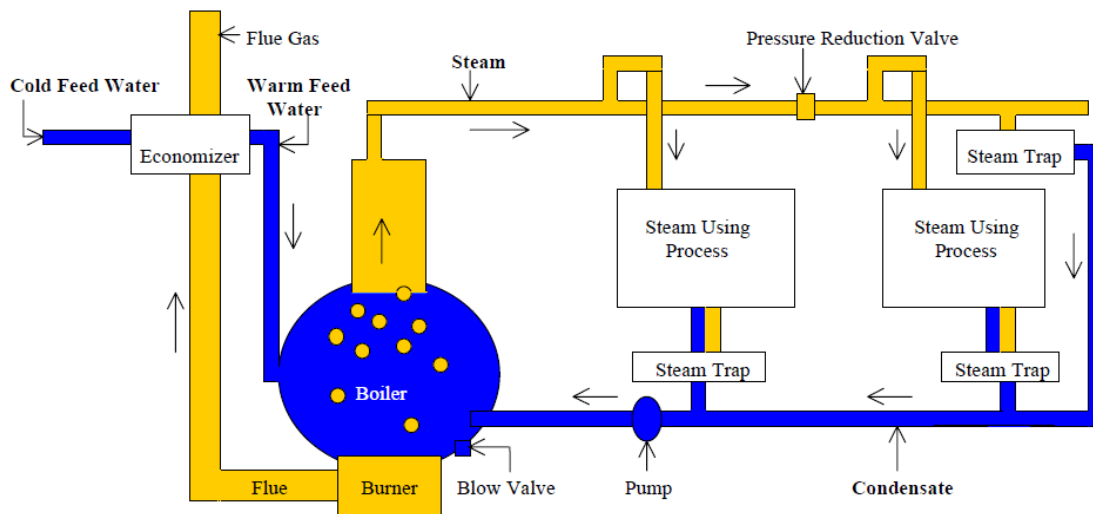

Figure 1: Schematic presentation of a steam production and distribution system.

Steam flow meters are commonly used to help evaluate the performance of the steam system. They retrieve information on the boiler performance, calculate boiler efficiency and determine the amount of steam needed by the system (U.S. DOE, 2012). In addition, their use can facilitate benchmarking the steam system and help identify opportunities for energy efficiency improvements.

There are two basic steam flow meter types (Parker et al., 2015):

- i) *differential pressure meters* that rely on the relationship between the pressure difference through an element used in the steam flow to define steam velocity. Main types are the Orifice, Annubar, and spring-loaded variable.
- ii) *velocity meters* that directly measure the velocity of the steam flow. Main types are the Turbine and Vortex-Shedding meters. Because velocity meters directly measure the velocity of the flow, they are more accurate than differential pressure meters.

The Orifice differential pressure meter is the steam meter most widely used in the U.S. industry. Unfortunately, in many cases, meters are neglected and need to be recalibrated to obtain correct readings (U.S. DOE, 2005b).

For accurate readings, proper maintenance is crucial. Differential pressure systems should be checked monthly for properly connected and sealed pressure taps. Annual maintenance should include a thorough checkup of the state of the orifice and pressure taps. In the case of velocity meters, annual maintenance should include the checkup of the impeller blades and the bearings for any wear or damage (Parker et al., 2015).



## Energy Savings Checklist: Steam Systems

Steam Systems Checklist	✓
Are steam flow meters properly maintained?	
Is the whole system properly maintained?	
Does the burner use the proper fuel to air ratio?	
Is the system (e.g. boiler size, distribution lines) properly sized?	
Is waste heat recovered and reused?	
Are heat losses minimized?	
Do the steam turbines operate under optimum condition?	
Is the energy embodied in the pressure drop utilized?	

## Best Practices for Energy-Efficient Steam Systems

- **Integrate the process.** Exploit potential synergies in systems with multiple components for heating and cooling and use pinch analysis techniques to decrease energy use.
- **Perform total site pinch analysis.** Identify optimum side-wide utility levels by integrating the demands for heating and cooling and reduce the energy consumption by 20-30%.

### Steam Supply - Boiler

- **Match steam demand.** Use the right size boilers in the high-fire setting to improve energy efficiency.
- **Control boiler allocation.** Employ automatic controllers for all boilers in systems that use multiple boilers to shift the loads and maximize efficiency. Install automatic flow valves to shut off unused boilers.
- **Install boiler flue shut-off dampers.** Reduce hot air losses by fitting fully closing stack dampers.
- **Perform maintenance.** Properly maintain the burner and condensate return systems to reduce the energy consumption by 10%.
- **Improve insulation.** Improve insulation and heater circuit controls and reduce the energy use by 6-26%.
- **Reduce fouling.** Remove scale deposits built on the water side of the boiler to improve heat transfer and reduce fuel use by up to 5%.
- **Optimize boiler blowdown rate.** Optimize the blowdown rate to reduce energy losses, makeup water and chemical treatment costs.
- **Reduce excessive flue gas quantities.** Repair leaks in the boiler and the flue that can lead to excessive flue gases.

#### Maintenance

**Unmaintained boiler systems can cost 20-30% of initial energy efficiency over 2-3 years.**

- **Reduce excess air.** Check the burner fuel to air ratio on a regular basis to reduce the amount of wasted heat. Controlling the combustion process digitally can improve energy efficiency by 3-5%.
- **Monitor flue gas.** Adopt flue gas monitoring to optimize the fuel to air ratio and detect scale deposition to improve efficiency.
- **Install turbulators on two- and three-pass firetube boilers.** Place turbulators into the boiler tubes to improve heat transfer and improve boiler efficiency.
- **Use an economizer.** Preheat boiler feed water from flue gases in an economizer and reduce fuel use by 5-10%.
- **Recover heat from boiler blowdown.** Use the heat from boiler blow down for space heating or feed water preheating to improve energy efficiency.
- **Reduce standby losses.** Reduce the losses from keeping boilers on standby. By installing an automatic control system, full capacity can be reached within 12 minutes.
- **Recover condensate.** Install a condensing economizer and improve overall heat recovery and system efficiency by up to 10%.

**Reduction of excess air**  
**As a rule of thumb, boiler efficiency can increase by 1% for each 15% reduction in excess air.**

#### *Steam Supply – Combined Heat and Power (CHP, see also below)*

- **Gas turbines.** Install a gas turbine to meet your power needs and recover the gas turbine exhaust to generate high pressure steam or use it in heating or drying applications.
- **Steam turbines.** Use high pressure steam in steam turbines to drive the process compressors and extract part of intermediate pressure steam to utilize in other equipment or processes.
- **Reciprocating engines.** Use modern reciprocating engines to generate electricity and recover the heat from the engine exhaust, cooling water, and lubricating oil to generate steam or to heat water.
- **Waste heat-to-power.** Capture discarded process heat to generate electricity.

#### *Steam Distribution*

- **Shut off excess distribution lines.** Reduce steam distribution losses in a cost-effective way by shutting off excess lines.
- **Properly size pipes.** When designing new steam distribution systems, account for the velocity and pressure drop and avoid high heat losses, pressure drops and erosion.

- **Insulate.** Reduce energy use by properly insulating the distribution system and by regularly inspecting and repairing worn insulation.
- **Check and monitor steam traps.** Adopt a scheme of regular steam trap checkups and follow up maintenance to save up to 10% of energy.
- **Use thermostatic steam traps.** Install thermostatic element steam traps and reduce energy use while improving reliability.
- **Shut off steam traps.** Shut off steam traps on superheated lines when not in use and save energy.
- **Reduce distribution pipe leaks.** Create a program of leak detection and maintenance on distribution pipes to decrease losses.
- **Recover low-pressure waste steam through vapor recompression.** Compress low pressure waste steam to higher pressures so that it can be reused. Recompression will only need 5-10% of the energy required to raise an equivalent amount of steam in a boiler.
- **Recover flash steam.** Use a heat exchanger to recover the heat in flash steam to use it for space heating or feed water preheating.

### Integrate the process.

Process integration exploits potential synergies that are inherent in any system that consists of multiple components working together. In plants that have multiple heating and cooling demands, the use of *pinch analysis* techniques may significantly improve efficiencies. Developed in the early 1970's, pinch analysis is now a well-established methodology for continuous processes (Linnhoff et al., 1992). The methodology involves the linking of hot and cold streams in a process in a thermodynamically optimal way (i.e. not over the so-called 'pinch'). Process integration is the art of ensuring that the components are well suited and matched in terms of size, function and capability. Pinch analysis takes a systematic approach to identifying and correcting the performance limiting constraint (or pinch) in any manufacturing process (Linnhoff, 1993). The pinch approach has been extended to resource conservation in general, whether the resource is capital, time, labor, electrical power, water or a specific chemical compound such as hydrogen.

The critical innovation in applying pinch analysis was the development of "composite curves" for heating and cooling, which represent the overall thermal energy demand and availability profiles for the process as a whole. When these two curves are drawn on a temperature enthalpy graph, they reveal the location of the process pinch (the point of closest temperature approach), and the minimum thermodynamic heating and cooling requirements. These are called the energy targets. The methodology involves first identifying the targets and then following a systematic procedure for designing heat exchanger networks to achieve these targets. The optimum approach temperature at the pinch is determined by balancing the capital-energy tradeoffs to achieve the desired payback. The procedure applies equally well to new designs as well as to retrofit of existing plants.

The analytical approach to this analysis has been well documented (Smith, 1995; Shenoy, 1994). The energy savings potential using pinch analysis far exceeds that from well-known conventional techniques such as heat recovery from boiler flue gas, insulation and steam trap management. Pinch analysis, and

competing process integration tools, have been developed further in recent years. The most important developments in the energy area are the inclusion of alternative heat recovery processes such as heat pumps and heat transformers, as well as the development of pinch analysis for batch processes (or in other words bringing in time as a factor in the analysis of heat integration). Furthermore, pinch analysis should be used in the design of new processes and plants, as process integration goes beyond optimization of heat exchanger networks (Hallale, 2001). Even in new designs additional opportunities for energy efficiency improvement can be identified. Pinch analysis has also been extended to the areas of water recovery and efficiency, and hydrogen recovery.

### Perform total site pinch analysis.

*Total Site Pinch Analysis* has been applied by many chemical sites around the world to find optimum site-wide utility levels by integrating heating and cooling demands of various processes, and by allowing the integration of combined heat and power (CHP) into the analysis. Process integration analysis of existing processes should be performed regularly, as continuous changes in product mix, mass flows and applied processes can provide new or improved opportunities for energy and resource efficiency.

Typical savings identified in site-wide analyses are around 20-30%. Savings of 10-15% are achievable under normal economic investment criteria (Linnhoff-March, 2000). Total site pinch analysis has been applied at over 100 sites in many industries on all continents.

**CASE STUDIES** The J.R. Simplot Don plant in Pocatello, Idaho, repaired the boiler feed water pumps and revised boiler operating practices to reduce steam venting by 17 million pounds annually. The Don plant produces over 1 million tons of phosphate fertilizers, feed phosphates, and related industrial products annually. After a steam system assessment, boiler operation was adapted to reduce steam venting, improve condensate recovery, and repair steam traps and steam leaks. The plant realized total annual cost savings of \$335,000, and energy savings of more than 75,000 MMBtu. With project costs of approximately \$180,000, the simple payback was 6.5 months.

A similar energy assessment was carried out in 2006 in an ammonia plant in Terra Nitrogen Company, L.P. Verdigris, Oklahoma plant. This revealed that upgrading steam turbines could reduce annual energy consumption by approximately 497,000 MMBtu and costs by about \$3.5 million. The upgrade involved the replacement of two back-pressure turbines with more efficient condensing turbines (U.S. DOE, 2007b). Estimated costs were about \$3.1 million, for a simple payback of about 11 months.

## *Steam Supply – Boiler*

### **Match steam demand.**

A boiler is more efficient in the high-fire setting. Since heating demands may change over time, situations can occur in which a boiler is operating beneath its optimum efficiency. Also, boilers may have been oversized because of anticipated additions or expansions that never occurred, or, later, equipment may have been replaced or discarded from the boiler. Energy conservation or heat recovery measures may also have reduced the heat demand. Thus, a facility may have multiple boilers, each rated at several times the maximum expected load (U.S. DOE, 2006b). Another common problem with oversized boilers is boiler “short cycling”, which occurs when an oversized boiler quickly satisfies process or space heating demands, and then shuts down until heat is again required.

Fuel savings can be achieved by adding a smaller boiler to a system, sized to meet average loads at a facility, or by re-engineering the power plant to consist of multiple small boilers. Multiple small boilers offer reliability and flexibility to operators to follow load swings without over-firing and short cycling. Facilities with large seasonal variations in steam demand should operate small boilers when demand drops, rather than operating large boilers year-round.

Measures to run boilers on the high-fire setting have an average payback time of slightly less than 1 year. Installation of smaller boilers to increase the high-fire duty cycle has an average payback time of less than 2 years (IAC, 2015).

### **Control boiler allocation.**

Systems containing multiple boilers offer energy-saving opportunities by using proper boiler allocation strategies. This is especially true if multiple boilers are operated simultaneously at low-fire conditions.

Automatic controllers determine the incremental costs (change in steam cost/change in load) for each boiler in the facility, and then shift loads accordingly. This maximizes efficiency and reduces energy costs. If possible, loads should be scheduled to optimize boiler system performance.

The efficiency of hot water boilers can improve with automatic flow valves. Automatic flow valves shut off boilers that are not being used, preventing hot water from the fired boiler from cooling as it passes through unused boilers in the system. Where valves are left open, the average flow temperature is lower than designed for and more fuel is used (CADET, 2001b).

### **Install flue shut-off dampers.**

Where boilers are regularly shut down due to load changes, heat loss to the chimney can be significant. A solution to stop hot air loss is to fit fully closing stack dampers, which only operate when the boiler is not required. Another alternative is to fit similar gas tight dampers to the fan intake (CADET, 2001b).

### **Perform maintenance.**

In the absence of a good maintenance system, the burners and condensate return systems can wear or go out of adjustment. These factors can end up costing a steam system up to 20-30% of initial efficiency

over 2-3 years (U.S. DOE, 2001b). A simple maintenance program ensures that all components of the boiler are operating at peak performance and can result in substantial savings and reduce air pollutant emissions. On average, energy savings are estimated at 10% (U.S. DOE, 2001b). Establishing a maintenance schedule for boilers has an average payback time of 0.2 years (IAC, 2015).

### **Improve insulation.**

The shell losses of a well-maintained boiler should be less than 1%. New insulation materials insulate better and have a lower heat capacity. As a result, the output temperature is more vulnerable to temperature fluctuations in the heating elements. Improved control is required to maintain the output temperature range of the old firebrick system. Savings of 6-26% can be achieved by combining improved insulation with improved heater circuit controls (Caffal, 1995).

### **Reduce fouling.**

Fouling of the fireside of the boiler tubes and scaling waterside of the boiler should be controlled. Tests show that a soot layer of 0.03 inches (0.8 mm) reduces heat transfer by 9.5%, while a 0.18 inch (4.5 mm) layer reduces heat transfer by 69% (CIPEC, 2001). Scale deposits occur when calcium, magnesium, and silica, commonly found in most water supplies, react to form a continuous layer of material on the waterside of the boiler heat exchange tubes. Tests show that for water-tube boilers, 0.04 inches (1 mm) of buildup can increase fuel consumption by 2% (CIPEC, 2001). In fire-tube boilers scaling can lead to a fuel waste up to 5% (U.S. DOE, 2006b). Moreover, scaling may result in tube failures.

Scale removal can be achieved by mechanical means or acid cleaning. The presence of scale can be indicated by the flue gas temperature (see flue gas monitoring) or be determined by visual inspection of the boiler tubes when the unit is shut down for maintenance. Fouling and scaling are more of a problem with coal-fed boilers than natural gas or oil-fed units. Boilers that burn solid fuels like coal should be checked more often as they have a higher fouling tendency than liquid fuel boilers (U.S. DOE, 2006b).

### **Optimize boiler blowdown rate.**

Insufficient blowdown may lead to carryover of boiler water into the steam, or the formation of deposits. Excessive blowdown wastes energy, water, and chemicals. The optimum blowdown rate is determined by various factors including the boiler type, operating pressure, water treatment, and quality of makeup water.

Blowdown rates typically range from 4% to 8% depending on boiler feed water flow rate, but can be as high as 10% when makeup water has a high solids content (U.S. DOE, 2006b). Minimizing blowdown rate can substantially reduce energy losses, makeup water and chemical treatment costs. The reduction of the blowdown rate has an average payback time of less than 1 year (IAC, 2015).

Optimum blowdown rates can be achieved with an automatic blowdown-control system. In many cases, the savings due to such a system can provide a simple payback of 1 to 3 years (U.S. DOE, 2006b).

### Reduce excessive flue gas quantities.

Often, excessive flue gas results from leaks in the boiler and the flue, reducing the heat transferred to the steam, and increasing pumping requirements. These leaks are often easily repaired. This measure consists of a periodic repair based on visual inspection or on flue gas monitoring which is discussed below.

### Reduce excess air.

The more air used to burn the fuel, the more heat is wasted to unnecessarily heat excess air. Air slightly more than the ideal stoichiometric fuel/air ratio is required for safety, to reduce NO<sub>x</sub> emissions, and depends on the type of fuel. Poorly maintained boilers can have up to 140% excess air leading to excessive amounts of waste gas. An efficient natural gas burner requires 2% to 3% excess oxygen, or 10% to 15% excess air in the flue gas, to burn fuel without forming carbon monoxide. A rule of thumb is that boiler efficiency can be increased by 1% for each 15% reduction in excess air (U.S. DOE, 2006b). Fuel-air ratios of the burners should be checked regularly. On average the analysis and adjustment of proper air/fuel mixture had a payback time of 0.6 years.

An efficient burner provides the proper air-to-fuel mixture throughout the full range of firing rates, without constant adjustment. Traditionally, this mixture was controlled using linkages or cables to position the air and fuel valves. These are subject to wear, repeatability difficulties and a limited amount of adjustment. Modern burners are an alternative to complex linkage designs and are increasingly using servomotors with parallel positioning to independently control the quantities of fuel and air delivered to the burner head. These controls provide consistent performance and repeatability as the burner adjusts to different firing rates (U.S. DOE, 2006b). Implementing a digital system results in greater control of the combustion process and leads to an improvement in energy efficiency of 3-5% (CADDET, 2001b). Replacement of inefficient obsolete burners averages a payback period of about 2 years (IAC, 2015).

Using a combination of CO and oxygen readings, it is possible to optimize the fuel/air mixture for high flame temperature (and thus the best energy efficiency) and low emissions (see flue gas monitoring).

### Monitor flue gas.

The oxygen content of exhaust gas is a combination of excess air (which is deliberately introduced to improve safety or reduce emissions) and air infiltration (air leaking into the boiler). By combining an oxygen monitor with an intake airflow monitor, it is possible to detect small leaks. Using a combination of carbon monoxide (CO) and oxygen readings, it is possible to optimize the fuel/air mixture for high flame temperature, best energy efficiency, and low emissions. The payback of installing flue gas analyzers to determine proper air/fuel ratios on average is about 0.6 years (IAC, 2015).

Monitoring flue gas temperature can also help to indicate scaling, since the flue gas temperature is an indirect indicator of scale or deposit formation. If the flue gas temperature rises (with boiler load and excess air held constant), the effect is likely due to the presence of scale.

The percentage of oxygen in the flue gas can be measured by inexpensive gas-absorbing test kits. More expensive hand-held, computer-based analyzers (ranging in cost from \$500 to \$1,000) display percentage of oxygen, stack gas temperature, and boiler efficiency. They are a recommended investment for any boiler system with annual fuel costs exceeding \$50,000 (U.S. DOE, 2006b).



### **Install turbulators on two- and three-pass firetube boilers.**

The packaged firetube boiler is the most common boiler design used to provide heating or process steam in industrial and heavy commercial applications. In a firetube boiler, hot combustion gases pass through long, small-diameter tubes where heat is transferred to water through the tube walls. These gases enter the tubes in a turbulent flow regime. Within a few feet laminar flow begins and a boundary layer of cooler gas forms along the tube walls. This layer serves as a barrier, retarding heat transfer. Turbulators, which consist of small baffles, angular metal strips, spiral blades, or coiled wire, may be inserted into the boiler tubes to break up the laminar boundary layer (U.S. DOE, 2006b). This increases the turbulence of the hot combustion gases and the convective heat transfer to the tube surface. The result is improved boiler efficiency. Turbulator installers can also balance gas flow through the tubes by placing longer turbulators in the uppermost tubes. This practice increases the effectiveness of the available heat-transfer surface by eliminating thermal stratification and balancing the gas flow through the firetubes.

The cost of installing turbulators is about \$10 to \$15 per boiler tube and the average payback time is 1 year (IAC, 2015). A manufacturing facility installed 150 turbulators into its firetube boiler. Tests conducted both before and after turbulator installation indicated a reduction in the stack gas temperature of 130°F (55°C). More combustion heat was being transferred into the boiler water. Each 40°F (22°C) reduction in the boiler flue gas temperature results in a 1% boiler-efficiency improvement, so overall boiler efficiency was improved by about 3.3%, while fuel costs decreased by approximately 4%.

### **Preheat boiler feed water with heat from flue gas (economizer).**

Heat from flue gases can be used to preheat boiler feed water in an economizer. By preheating the water supply, the temperature of the water at the inlet to the boiler is increased, reducing the amount of heat necessary to generate steam and save fuel. While this measure is fairly common in large boilers, there often is the potential to increase heat recovery.

The limiting factor for flue gas heat recovery is the economizer wall temperature that should not drop below the dew point of acids in the flue gas. Traditionally this is done by keeping the flue gases at a temperature significantly above the acid dew point. However, the economizer wall temperature is more dependent on the feed water temperature than on the flue gas temperature because of the high heat transfer coefficient of water. Thus, it makes more sense to preheat the feed water to close to the acid dew point before it enters the economizer. This allows the economizer to be designed so that the flue gas exiting the economizer is just above the acid dew point.

Generally, boiler efficiency can be increased by 1% for every 40°F (22°C) reduction in flue gas temperature. By recovering waste heat, an economizer can often reduce fuel requirements by 5% to 10% and pay for itself in less than 2 years (U.S. DOE, 2006b).

### **Recover heat from boiler blowdown.**

When the water is blown from the high-pressure boiler tank, the pressure reduction often produces substantial amounts of steam. Up to 80% of the heat in the discharge is recoverable by using flash vessels and heat exchangers (CADET, 2001b). The recovered heat can subsequently be used for space heating and feed water preheating, increasing the efficiency of the system. Any boiler with continuous blowdown

exceeding 5% of the steam rate is a good candidate for the introduction of blowdown waste heat recovery. If there is a non-continuous blowdown system, then consider the option of converting it to a continuous blowdown system coupled with heat recovery (U.S. DOE, 2006b). Larger energy savings occur with high-pressure boilers. The use of heat from boiler blowdown on average has payback period of about 1.5 years (IAC, 2015).

### Reduce standby losses.

In an ammonia plant, often one or more boilers are kept on standby in case of failure of the operating boiler. By modifying the burner, combustion air supply and boiler feedwater supply, steam production at standby can be reduced to virtually zero. By installing an automatic control system, the boiler can reach full capacity within 12 minutes. Energy savings up to 85% of the standby boiler are achieved by installing the control system and modifying the boiler. Actual figures depend on the use pattern of the boiler (Worrell and Galitsky, 2005).

**CASE STUDY:** The Kemira Oy ammonia plant at Rozenburg (The Netherlands, now closed) applied this system to a small 44 tons/hr steam boiler, reducing the standby steam consumption from the boiler from 7 tons/hr to 1 ton/hr. This resulted in energy savings of 54,000 MMBtu/year. Investments were approximately \$270,000, resulting in a payback period of 1.5 years at this plant (CADDET, 1997a).

### Recover condensate.

By installing a condensing economizer, companies can improve overall heat recovery and steam system efficiency by up to 10% (U.S. DOE, 2007a). Many boiler applications can benefit from additional heat recovery. Condensing economizers require site-specific engineering and design, and a thorough understanding of the effect they will have on the existing steam system and water chemistry.

Hot condensate can be returned to the boiler to save energy and reduce the need for treated boiler feed water since condensate, being condensed steam, is extremely pure and has high heat content. Increasing the amount of returned condensate has an average payback period of about 1 year (IAC, 2015). Condensate has also been used to provide for hot water supply. This measure had an average payback period of 0.7 years (IAC, 2015). Care should be taken to prevent the forming of corrosion. Corrosion in condensate systems can limit the quality or quantity of returned condensate, may contain iron and copper corrosion products, and can deposit on boiler heat transfer surfaces, reducing heat transfer efficiency. In addition, corrosion may cause steam leaks, increasing maintenance and equipment costs.

### *Steam Supply – Combined Heat and Power (CHP)*

Combined heat and power (CHP) is an efficient and clean approach to generating electric power and useful thermal energy from a single fuel source. CHP is used either to replace or supplement conventional separate heat and power (SHP). Instead of purchasing electricity from the local utility and burning fuel in an on-site furnace or boiler to produce thermal energy, facilities can use CHP on-site to provide both energy services in one energy-efficient process. In this way, and by avoiding distribution losses, CHP can

achieve total efficiencies of over 80 percent, compared to 50 percent for conventional technologies (i.e., grid-supplied electricity and an on-site boiler).

Applications with steady demand for electricity and thermal energy are potentially good economic targets for CHP deployment. Industrial applications, particularly in industries with continuous processing and high steam requirements, tend to be the most economic and represent most existing CHP capacity (U.S. EPA, 2015).

Properly sized and configured CHP systems can effectively insulate facilities from a grid failure, providing continuity of critical operations. The design elements necessary so that a CHP system can be isolated from the grid – i.e. operate in “island” mode – are system-specific and include additional controls and switchgear equipment (ORNL, 2013)

The cost benefits of power export to the grid will depend on the regulation where the industry is located, but can provide a major economic incentive. Not all states allow wheeling of power (i.e. sales of power directly to another customer using the grid for transport) and for the states that do allow wheeling, regulations may also differ with respect to the tariff structure for power sales to the grid operator.

Most CHP systems consist of several individual components – prime mover (heat engine), generator, heat recovery, and electrical interconnection – configured into an integrated system. The type of equipment that drives the overall system (i.e., the prime mover) typically identifies the CHP system (U.S. EPA, 2015). Ninety-seven percent of the CHP projects in place today and 99 percent of the total installed CHP electric capacity are represented by five technologies: reciprocating engines, gas turbines (that include gas turbine/steam turbine combined cycles), boiler/steam turbine, microturbine and fuel cells (U.S. EPA, 2015).

CHP systems are classified as either as topping-cycle or bottoming-cycle CHP. In topping-cycle CHP systems, fuel is used to generate electricity. Waste heat from the prime mover is then recovered and used for steam, hot water, process heating, and/or cooling applications. In bottoming cycle CHP systems, high-temperature thermal energy is first used for industrial applications, such as metal smelting furnaces, and the waste heat is then recovered and used to drive a turbine to produce electric power.

The [technology choice](http://info.ornl.gov/sites/publications/files/Pub13655.pdf) (see <http://info.ornl.gov/sites/publications/files/Pub13655.pdf>) for a CHP facility depends on available fuel and the amount of generating capacity needed (EIA, 2012). The U.S. DOE CHP installation database identifies a dozen topping cycle CHP units (476 MW) in the fertilizer industry. These installations can be found in Appendix H, arranged chronologically starting with the earliest application installed to operate in 1942 and still in operation and the most recent CHP unit went into operation in 2015.

To be concise, this section provides only a quick overview of CHP applications and technologies used in the fertilizer industry. For more information on CHP systems, the reader is referred to Oland (2004).

### **Gas turbines.**

Gas turbines are used to meet many different power needs, including propulsion, direct drive, and stationary electricity generation. Gas turbines are well suited for industrial CHP applications because the high temperature gas turbine exhaust can be used to generate high pressure steam, or it can be used directly for heating or drying applications. Some industrial CHP systems use gas turbine exhaust to heat

the input of a furnace or to preheat combustion air. This option may require replacing existing furnaces, since the radiative heat transfer from gas turbine exhaust gases is much smaller than from combustion gases, due to their lower temperature (Worrell et al., 1997).

Gas turbine exhaust can be used in ammonia plants to drive the process air compressor, as an alternative to a steam turbine driven compressor. Most of the older ammonia plants have steam turbine driven air compressors, which generally have low efficiencies. When using a condensation steam turbine to drive the process air compressor, more than 50% of the energy contained in the steam is lost as it is transferred to the cooling medium through condensation. Instead, gas turbine exhaust gases can be used as hot combustion air for the radiant burners in the primary reformer. Using the hot exhaust gas in the primary reformer leads to fuel savings for the firing of the reformer, though higher flame temperatures might increase the NO<sub>x</sub> formation (IPT/EC, 2007; Verduijn and de Wit, 2001). With this process, an overall efficiency of more than 90% can be achieved for driving and preheat operations.

Gas turbines can range from 1 MW to hundreds of megawatts, and they can be utilized as simple cycle turbines or as part of a combined cycle where recovered steam is used to power a secondary steam turbine. Some recent designs use a Cheng cycle which injects steam directly into the gas turbine to boost power output. Electric efficiencies for simple cycle gas turbines can approach 40 percent (HHV), but efficiency degrades quickly as the load is decreased, so gas turbines are best-suited for applications where the system operates at near-constant full load.

### Steam turbines.

Steam turbines have been used for electricity production since the 1880s, and most of the electricity generated in the U.S. is produced by steam turbines at central station power plants. Steam turbines only require a source of heat sufficient to produce high pressure steam, so any type of fuel (or high-temperature heat source) can be used to produce power. Other than central station power, steam turbines are commonly paired with boilers for CHP applications at industrial manufacturing facilities. Steam turbines can come in all sizes, from under 100 kW to over 200 MW, and they are the most common type of CHP installation at fertilizer plants.

The efficiency of steam turbines is determined by the inlet steam pressure and temperature as well as the outlet pressure. Each turbine is designed for a certain steam inlet pressure and temperature, and operators should make sure that the steam inlet temperature and pressure are optimal. An 18°F decrease in steam inlet temperature will reduce the efficiency of the steam turbine by 1.1% (Patel and Nath, 2000).

In industrial CHP applications, some steam is used for on-site thermal processes, and some is used to generate electricity. Most industrial steam turbine configurations use back-pressure or extraction turbines to produce steam at specific pressures for industrial processes, filling the role of pressure reduction valves.

**CASE STUDY:** In an energy efficiency assessment of 3M's Hutchinson, Minnesota, facility, the installation of a steam turbine replacing a pressure reduction valve was identified as a project that would save 3,166 MWh of electricity per year. Capital costs for the project were estimated at \$604,034 and avoided first year energy expenses at \$163,999 (U.S. DOE, 2003a), resulting in a payback period of 3-4 years.

At ammonia plants, all of the high pressure steam generated from chemical processes is fed to steam turbines that drive the synthesis compressor. At an intermediate pressure level, part of the steam is extracted from the turbine and used to supply the process steam in the reformer and to drive other compressors, fans and pumps. The rest of the steam is condensed (IPTS/EC, 2007).

In recent decades, steam turbine technology has improved significantly (e.g. materials, blade types, integration). Older steam turbines may be retrofitted to enhance their performance. Based on existing projects efficiency improvements of between 2.5-10% are to be expected. The higher end of the savings potential is applicable to older turbines (in the range of 30 years). The retrofit would lead to an increase in the capacity of the steam turbine while fuel use would remain the same. The payback time of the steam turbine upgrade is usually in the order of 1 year. Costs can be reduced by including the upgrade in the normal turn-around schedule.

### **Reciprocating engines.**

There are two primary reciprocating engine designs relevant to stationary power generation applications – the spark ignition Otto-cycle engine and the compression ignition Diesel-cycle engine. For baseload power and CHP applications, spark ignition natural gas-fueled engines tend to be used, with capacities ranging from 10 kW to 10 MW.

Reciprocating engines represent over 50 percent of all installed CHP systems, with engines fueled by natural gas and other gaseous fuels accounting for most of the installed capacity. Modern reciprocating engines are some of the most efficient CHP technologies, reaching over 40 percent electric efficiency and 80 percent total CHP efficiency (HHV). Thermal energy can be recovered from three sources: 1) engine exhaust, 2) cooling water, and 3) lubricating oil. Steam can be produced from the exhaust of some larger engines, but thermal energy from cooling water and lubricating oil can only be used to produce hot water (or chilled water with an absorption chiller).

Due to the limited thermal applications, reciprocating engines are not heavily used in the fertilizer industry, with only one known CHP installation.

### **Waste heat-to-power.**

Waste heat to power (WHP) is the process of capturing heat discarded by an existing industrial process and using that heat to generate power (U.S. EPA, 2012). Energy-intensive industrial processes—such as those occurring at refineries, steel mills, glass furnaces, and cement kilns—all release hot exhaust gases and waste streams that can be harnessed with well-established technologies to generate electricity.

Waste heat streams can be used to generate power in what is called bottoming cycle CHP. In this configuration, fuel is first used to provide thermal energy in an industrial process, such as a furnace, and the waste heat from that process is then used to generate power. The key advantage of this type of WHP systems is that they utilize heat, produced at necessary high temperatures from existing thermal processes, which would otherwise be wasted, to produce electricity or mechanical power, as opposed to directly consuming additional fuel for this purpose. At fertilizer plants, exothermic chemical reactions produce large amounts of waste heat that can be incorporated into WHP systems. However, these systems are not considered CHP as the heat is not utilized for any thermal processes (U.S. DOE, 2015).

Most WHP systems use the Rankine cycle, either with steam or with an organic fluid when the waste heat sources have a lower boiling point. The working fluid is pumped to a heat recovery boiler where the fluid is evaporated, passed through a turbine to generate power, and then condensed and returned to the boiler. In the fertilizer industry, there are many exothermic chemical processes that produce heat, and the heat can be recovered and used to generate electricity.

The working fluid for WHP systems is chosen based on the temperature and characteristics of the waste heat source. Steam can only be used with high-temperature (>700°F) heat sources, while heat sources from 300 to 700°F can use other organic working fluids (typically different types of refrigerants). There are six known WHP installations currently operating in the U.S. fertilizer industry, shown in Appendix H, and there are likely opportunities for additional economic applications at fertilizer plants.

### *Steam Distribution*

#### **Shut off excess distribution lines.**

Installations and steam demands change over time, which may lead to under-utilization of steam distribution capacity, and extra heat losses. It may be too expensive to optimize the system for changed steam demands. Still, checking for excess distribution lines and shutting off those lines is a cost-effective way to reduce steam distribution losses.

#### **Properly size pipes.**

When designing new steam distribution systems, it is very important to account for the velocity and pressure drop. This reduces the risk of oversizing a steam pipe, which is not only a cost issue but would also lead to higher heat losses. A pipe that is too small may lead to erosion and increased pressure drop (Van de Ruit, 2000).

#### **Insulate.**

Insulation can typically reduce energy losses by 90% and help ensure proper steam pressure at plant equipment (U.S. DOE, 2006b). The application of insulation can lead to significant energy cost savings with relatively short payback periods. For instance, the average payback period of insulation on steam and hot water lines, condensate lines, and feed water tanks is about 1 year (IAC, 2015). The improvement of existing insulation can often lead to further savings. This measure consists of applying more or better insulating material. Crucial factors in choosing insulating material include: low thermal conductivity, dimensional stability under temperature change, resistance to water absorption, and resistance to combustion. Other characteristics of insulating material may also be important depending on the application, e.g. tolerance of large temperature variations and system vibration, and compressive strength where insulation is load bearing (Baen and Barth, 1994).

Some types of insulation can become brittle, or rot. As a result, energy can be saved by a regular inspection and maintenance program (CIBO, 1998). The repair of faulty insulation has an average payback time of 0.4 years (IAC, 2015).

During maintenance, insulation that covers pipes, valves, and fittings is often damaged or removed and not replaced. This can be avoided by using removable and reusable insulating pads which are available to cover almost any surface (U.S. DOE, 2006b).

### **Check and monitor steam traps.**

A simple program of checking steam traps to ensure proper operation can save significant amounts of energy. If the steam traps are not maintained for 3 to 5 years, 15-30% of the traps can be malfunctioning, thus allowing live steam to escape into the condensate return system. In systems with a regularly scheduled maintenance program, leaking traps should account for less than 5% of the trap population (U.S. DOE, 2006b). The repair and replacement of steam traps has an average payback time of about 0.4 years (IAC, 2015). Energy savings for a regular system of steam trap checks and follow-up maintenance is estimated to be up to 10% (Jones, 1997; Bloss et al., 1997). Attaching automated monitors to steam traps in conjunction with a maintenance program can save even more energy, without significant added cost. Such a system is an improvement over steam trap maintenance alone, because it gives quicker notice of steam trap malfunctioning or failure. Using automatic monitoring is estimated to save an additional 5% over regular steam trap maintenance, with a payback of about 1 year.

### **Use thermostatic steam traps.**

Using modern thermostatic element steam traps can reduce energy use while improving reliability. The main advantages offered by these traps are that they open when the temperature is close to that of the saturated steam (within 0.6°F (2°C)), purge non-condensable gases after each opening, and are open on startup to allow a fast steam system warm-up. These traps are also very reliable, and useable for a large range of steam pressures (Alesson, 1995). Energy savings will vary depending on the steam traps installed and the state of maintenance.

Examples of thermostatic traps are pinch traps. In these traps, a modulator automatically closes off flow as a chemically resistant elastomer around the modulator expands with the passage of hot condensate. As the condensate builds up and cools, the elastomer around the modulator contracts, allowing the orifice to open and create flow. It automatically responds to condensate temperature, has no live steam losses and uses energy in the steam line at maximum efficiency (Kane et al., 1998).

### **Shut off steam traps.**

Energy savings can come from shutting off steam traps on superheated steam lines when they are not in use. This measure has an immediate payback (IAC, 2015).

### **Reduce distribution pipe leaks.**

As with steam traps, the distribution pipes themselves often have leaks that go unnoticed without a program of regular inspection and maintenance. On average leak repair has a payback period of 0.3 years (IAC, 2015).



### **Recover low-pressure waste steam through vapor recompression.**

Low-pressure steam exhaust from industrial operations is usually vented to the atmosphere or condensed in a cooling tower. Simultaneously, other plant operations may require intermediate-pressure steam at 20 to 50 psig. Instead of letting down high-pressure steam across a throttling valve to meet these needs, low-pressure waste steam can be mechanically compressed or boosted to a higher pressure so that it can be reused. Recovery of the latent heat content of low-pressure steam reduces the boiler load, resulting in energy and fuel cost savings. Low-pressure steam potential uses include driving evaporation and distillation processes, producing hot water, space heating, producing a vacuum, or chilling water.

Vapor recompression relies upon a mechanical compressor or steam jet ejector to increase the temperature of the latent heat in steam to render it usable for process duties. It is noted that the steam jet ejector is known for its simple construction, insensitivity to fouling, easy installation, low capital and installation costs, easy maintenance with no moving parts, and long useful operating lives.

Recompression typically requires only 5% to 10% of the energy required to raise an equivalent amount of steam in a boiler. Vapor recompression can be used in steam distribution systems to boost system pressures that have dropped to unacceptably low levels (U.S. DOE, 2006b).

### **Recover flash steam.**

When a steam trap purges condensate from a pressurized steam distribution system to ambient pressure, flash steam is produced. Depending on the pressures involved, the flash steam contains approximately 10% to 40% of the energy content of the original condensate. This energy can be recovered by a heat exchanger and used for space heating or feed water preheating (Johnston, 1995; U.S. DOE, 2006b). The potential for this measure is site dependent, as it is unlikely that a plant will build an entirely new system of pipes to transport this low-grade steam, unless it can be used close to the steam traps. Sites using multi-pressure steam systems can route the flash steam formed from high-pressure condensate to reduced pressure systems.

The flashing of high pressure condensate can regenerate low-pressure steam. Low-pressure process steam requirements are usually met by throttling high-pressure steam, but a portion of the process requirements can be achieved at low cost by flashing high-pressure condensate. Flashing is particularly attractive when it is not economically feasible to return the high-pressure condensate to the boiler. The economics of heat recovery projects are most favorable when the waste steam heat content is high and the flow continuous. Seasonal space heating is not the most desirable end use. Flashing of high pressure condensate to regenerate low-pressure steam has an average payback period of 0.7 years (IAC, 2015).

## Chapter Nine: Lighting

In this chapter:	
Turn off lights in unoccupied areas	Use occupancy sensors and other lighting controls
Upgrade exit signs	Replace magnetic ballasts with electronic ballasts
Replace T-12 tubes with T-8 tubes	Reduce lighting system voltage
Replace mercury lights with metal halide or high pressure sodium	Replace metal halide HID with high-intensity fluorescent lights
Use daylighting	Use LED lighting

Lighting is used either to provide overall ambient lighting throughout the manufacturing, storage and office spaces or to provide low bay and task lighting to specific areas. High-intensity discharge (HID) sources are used for the former, including metal halide, high-pressure sodium and mercury vapor lamps. Fluorescent, compact fluorescent (CFL) and incandescent lights are typically used for task lighting in offices.

### Energy Savings Checklist: Lighting

Lighting is a significant energy use and cost for many manufacturers and is an area with numerous opportunities for savings. Use the checklist below to find new ways to save energy and costs with lighting changes.

Lighting Checklist	✓
Are unoccupied areas lit?	
Are lights left on during non-work hours?	
Are parts of the facility overlit?	
Is older, inefficient technology in use?	
Are exit lights using old technology?	
Can daylighting be used?	
Are lighting controls in use?	
Is there a periodic review of lighting technology to ensure the most efficient technology is in use?	

## Opportunities for Energy Efficiency

There are many options and choices for providing appropriate lighting for specific settings. When the opportunity to install new or replace and upgrade existing lighting presents itself, understanding the various energy requirements, lifetime, uses, etc. for the numerous types of lighting sources can be an important part of energy management and savings in a manufacturing facility. Table 7 compares lighting sources.

Table 7. Performance comparison of lighting sources.

Lamp	Efficacy (Lumen/watt)	Typical Lifetime (Hours)	Applications
Incandescent	5–20	1,000	Task
Halogen	<24	1,000	Task
CFL	20–70	8,000–15,000	Task
Fluorescent T-12	60	20,000	Any
Fluorescent T-8	80–100	20,000	Any
Fluorescent T-5	80–105	20,000	Any
Mercury Vapor	30-50	60,000	Hi-Bay
Induction	80	100,000	Exterior, Hi-Bay
High Pressure Sodium	85–150	10,000–50,000	Exterior, Hi-Bay
Metal Halide	70–115	20,000	Hi-Bay
LED	10–120	50,000	Task

Note: Values are typical performance. Performance of individual products may vary. The performance of fluorescent lamps assumes the use of an electronic ballast. Technology development may change the future performance of these specific lighting technologies.

## Best Practices for Energy-Efficient Lighting

- **Turn off lights in unoccupied areas.** An easy and effective measure is to encourage personnel to turn off lights in unoccupied building spaces.
- **Use occupancy sensors and other lighting controls.** Lights can be shut off during non-working hours by automatic controls, such as occupancy sensors which turn off lights when a space is unoccupied.
- **Upgrade exit signs.** Energy costs can be reduced by switching from incandescent lamps to light emitting diodes (LED's) or radium strips in exit sign lighting.
- **Replace magnetic ballasts with electronic ballasts.** Electronic ballasts require 12 to 30% less power than magnetic ballasts.
- **Replace T-12 tubes with T-8 tubes.** Using T-8 lamps can save up to 30% in energy savings.
- **Reduce lighting system voltage.** Voltage controllers reduce voltage and save energy in HID or fluorescent lighting systems without losing light.
- **Replace mercury lights with metal halide or high pressure sodium lights.** Metal halide or high pressure sodium lights save up to 60% in energy.

- **Replace metal halide HID with high-intensity fluorescent lights.** High-intensity fluorescent systems yield 50% electricity savings over standard metal halide HID.
- **Use daylighting.** Increasing levels of daylight within rooms can reduce electrical lighting loads by up to 70%.
- **Use LED lighting.** LED lights use far less energy to emit the same lumens of light.

### Turn off lights in unoccupied areas.

An easy and effective measure is to encourage personnel to turn off lights in unoccupied building spaces. An energy management program that aims to improve the awareness of personnel with regard to energy use can help staff get in the habit of switching off lights and other equipment when not in use.

### Use occupancy sensors and other lighting controls.

Lights can be shut off during non-working hours by automatic controls, such as occupancy sensors, which turn off lights when a space is unoccupied. Manual controls can also be used in addition to automatic controls to save additional energy in smaller areas. Numerous case studies throughout the United States suggest that the average payback period for occupancy sensors is approximately 1 year (IAC, 2015).

Manual controls can be used in conjunction with automatic controls to save additional energy in smaller areas. One of the easiest measures is to install switches that allow occupants to control lights. Other lighting controls include daylight controls for indoor and outdoor lights, which adjust the intensity of electrical lighting based on the availability of daylight.

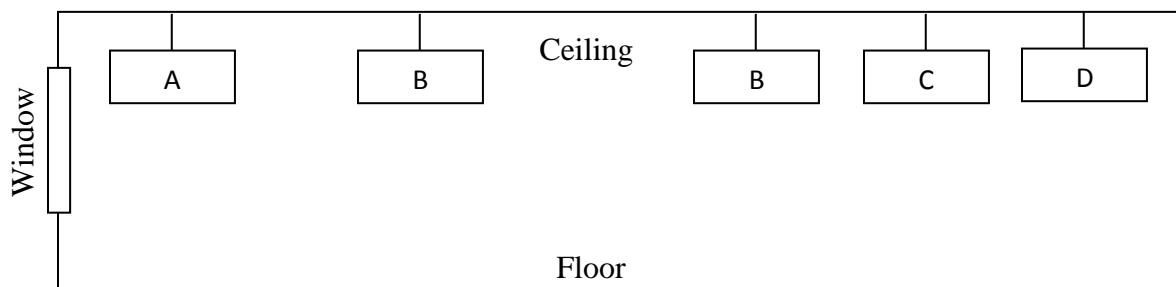

Figure 2: Lighting Placement and Controls.

### Upgrade exit signs.

Energy costs can be reduced by switching from incandescent lamps to light emitting diodes (LEDs) or radium strips in exit sign lighting. An incandescent exit sign uses about 40 W, while LED signs may use only about 4 W to 8 W, reducing electricity use by 80 to 90%. A 1998 Lighting Research Center survey found that about 80% of exit signs being sold use LEDs (LRC, 2001). The lifetime of an LED exit sign is about 10 years, compared to 1 year for incandescent signs, which can reduce exit sign maintenance costs considerably. In addition to exit signs, LEDs are increasingly being used for path marking and emergency way finding systems. Their long life and cool operation allows them to be embedded in plastic materials, which makes them well suited for such applications (LRC, 2001).

New LED exit signs are inexpensive, with prices typically starting at around \$20. The U.S. EPA's ENERGY STAR program website (<http://www.energystar.gov>) provides a list of suppliers of LED exit signs.

Tritium exit signs are an alternative to LED exit signs. Tritium signs are self-luminous and thus do not require an external power supply. The advertised lifetime of these signs is around 10 years and prices typically start at around \$150 per sign.

### **Replace magnetic ballasts with electronic ballasts.**

A ballast is a mechanism that regulates the amount of electricity required to start a lighting fixture and maintain a steady output of light. Electronic ballasts can require 12 to 30% less power than their magnetic predecessors (Cook, 1998; Galitsky et al., 2005). New electronic ballasts have smooth and silent dimming capabilities, in addition to longer lives (up to 50% longer), faster run-up times, and cooler operation than magnetic ballasts (Eley et al., 1993; Cook, 1998). New electronic ballasts also have automatic switch-off capabilities for faulty or end-of-life lamps.

### **Replace T-12 tubes with T-8 tubes.**

In industry, typically T-12 tubes have been used. T-12 refers to the diameter in 1/8 inch increments (T-12 means 12/8 inch or 3.8 cm diameter tubes). The initial output for these lights is high, but energy consumption is also high. They also have extremely poor efficacy, lamp life, lumen depreciation, and color rendering index. Because of this, maintenance and energy costs are high. Replacing T-12 lamps with T-8 lamps (smaller diameter) approximately doubles the efficacy of the former. Typical energy savings from the replacement of a T-12 lamp by a T-8 lamp are around 30% (Galitsky et al., 2005).

### **Reduce lighting system voltage.**

Reducing lighting system voltage can also save energy. A Toyota production facility installed reduced-voltage HID lights and realized a 30% reduction in lighting energy consumption (Galitsky et al., 2005). Commercial products are available that attach to a central panel switch (controllable by computer) and constrict the flow of electricity to lighting fixtures, thereby reducing voltage and saving energy, with an imperceptible loss of light. Voltage controllers work with both HID and fluorescent lighting systems and are available from multiple vendors.

### **Replace mercury lights with metal halide or high pressure sodium lights.**

Where color rendition is critical, metal halide lamps can replace mercury or fluorescent lamps with an energy savings of 50%. Where color rendition is not critical, high pressure sodium lamps offer energy savings of 50 to 60% compared to mercury lamps (Price and Ross, 1989). A plant-wide energy assessment at the Ford Cleveland Casting Plant (CCP) in Cleveland, Ohio identified the potential for 282,000 kWh savings in electricity consumption by replacing the 400-watt mercury lights with 360-watt metal halide lights. The payback period was estimated to be 3.7 years (U.S. DOE, 2003a).

### **Replace metal halide HID with high-intensity fluorescent lights.**

Traditional HID lighting can be replaced with high-intensity fluorescent lighting. These new systems incorporate high-efficiency fluorescent lamps, electronic ballasts and high-efficacy fixtures that maximize output to the work plane. Advantages to the new systems are many. They have lower energy consumption, lower lumen depreciation over the lifetime of the lamp, better dimming options, faster start-up and restrike capability, better color rendition, higher pupil lumens ratings and less glare (Martin et al., 2000). High-intensity fluorescent systems yield 50% electricity savings over standard metal halide HID. Dimming controls that are impractical in the metal halide HIDs can also save significant energy. Retrofitted systems cost about \$185 per fixture, including installation costs (Martin, et al., 2000). In addition to energy savings and better lighting qualities, high-intensity fluorescents can help improve productivity and have reduced maintenance costs.

### **Use daylighting.**

Daylighting involves the efficient use of natural light to minimize the need for artificial lighting in buildings. Increasing levels of daylight within rooms can reduce electrical lighting loads by up to 70% (CADET, 2001a; IEA, 2000). Unlike conventional skylights, an efficient daylighting system may provide evenly dispersed light without creating heat gains, which can reduce the need for cooling compared to skylights. Daylighting differs from other energy efficiency measures because its features are integral to the architecture of a building; therefore, it is applied primarily to new buildings and incorporated at the design stage. However, existing buildings can sometimes be cost-effectively refitted with daylighting systems.

Daylighting can be combined with lighting controls to maximize its benefits. Because of its variability, daylighting is almost always combined with artificial lighting to provide the necessary illumination on cloudy days or after dark. Daylighting technologies include properly placed and shaded windows, atria, clerestories, light shelves, and light ducts. Clerestories, light shelves, and light ducts can accommodate various angles of the sun and redirect daylight using walls or reflectors. More information on daylighting can be found at the website of the Daylighting Collaborative led by the Energy Center of Wisconsin (<http://www.daylighting.org/>).

### **Use LED lighting.**

Light emitting diode (LED) lights are the newest generation of energy-efficient lighting. In typical fluorescent lighting, electrical arcs are used to excite mercury and phosphorous compounds, which then emit light. On the other hand, LED lights are semiconductor diodes that use far less energy to emit the same lumens of light. Several new LED light products that are compatible with current light fixtures (such as T-8s) are emerging on the market, and prices for LED lighting are coming down rapidly. Commercial LED systems are marketed for many lighting applications. The long lifetime of LEDs is, next to energy efficiency, a key advantage, as it strongly reduces maintenance costs and energy costs. Including these cost savings in the investment decision generally will make a sound business case for LED lighting.

## Chapter Ten: Building HVAC

In this chapter:	
Employ an energy-efficient system design	Consider recommissioning before replacing
Install energy monitoring and control systems	Adjust non-production setback temperatures
Repair leaking ducts	Consider variable air volume systems
Install adjustable speed drives	Consider heat recovery systems
Modify your fans	Use ventilation fans
Install efficient exhaust fans	Add building insulation
Employ solar air heating	Modify building reflection
Install low-emittance windows	

HVAC stands for heating, ventilation, and air conditioning and refers to the equipment, distribution network, and terminals used either collectively or individually to provide fresh filtered air, heating, cooling, and humidity control in a building. The main goals of HVAC are to provide comfort and indoor air quality.

### Energy Savings Checklist: HVAC Systems

HVAC systems can be a significant energy load, so it is important to ensure that these systems are operating efficiently. Use the checklist below to identify new ways to save energy and costs with HVAC system changes.

HVAC Checklist	✓
Are temperature set points turned back during non-production hours?	
Are temperature set points at the right level?	
Is duct work leaking?	
Is the building well insulated?	
Are HVAC systems programmed correctly and operating according to manufacturer's instructions?	
Are coils cleaned regularly?	
Are air filters changed appropriately and regularly?	
Is older, inefficient technology being used?	
Are economizer control and models functioning properly?	
Have burners been maintained properly and calibrated annually?	
Have v-belts been replaced with energy-efficient belts (i.e. cog belt)?	

### Best Practices for Energy-Efficient HVAC Systems

- **Employ an energy efficient system design.** Sizing equipment properly and designing energy efficiency into a new facility minimizes energy consumption and operational costs of HVAC systems from the outset.
- **Consider recommissioning before replacement.** Recommissioning identifies problem areas that may be reducing building efficiency, and can help avoid the cost of new equipment.



- **Install energy monitoring and control systems.** These systems monitor, control, and track energy consumption to optimize consumption and help identify system problems.
- **Adjust non-production setback temperatures.** Adjusting temperatures during periods of non-use can significantly reduce HVAC energy consumption.
- **Repair leaking ducts.** Repairing duct leaks can reduce HVAC energy consumption up to 30%.
- **Consider variable air volume systems.** These systems match HVAC load to heating and cooling demands and reduce energy use.
- **Install adjustable speed drives (ASDs).** ASD's minimize consumption based on system demand to save energy.
- **Consider heat recovery systems.** These systems reduce the energy required to heat or cool intake air.
- **Modify your fans.** Changing the size or shape of the sheaves of a fan optimizes fan efficiency and airflow and reduces energy consumption.
- **Use ventilation fans.** Ventilation fans reduce the load on heating systems and lead to better air circulation.
- **Install efficient exhaust fans.** Impeller exhaust fans are up to 25% more efficient than centrifugal fans.
- **Add building insulation.** Insulation is an easy and effective way to reduce utility bills.
- **Employ solar air heating.** These systems use solar radiation for insulation and provide clean, fresh air.
- **Modify building reflection.** Use reflective roofing, "green" roofing or shading/windbreaks to increase energy efficiency.
- **Install low-emittance (Low-E) windows.** Insulating ability is increased through these windows.

### Employ an energy-efficient system design.

For HVAC systems in new industrial facilities, the greatest opportunities for energy efficiency arise at the design stage. Sizing equipment properly and designing energy efficiency into a new facility generally minimizes the energy consumption and operational costs of HVAC systems from the outset. This practice often saves money in the long run, as it is generally less expensive to install energy-efficient HVAC equipment during construction than it is to upgrade an existing building with an energy-efficient system later on, especially if those upgrades lead to downtime.

### Consider recommissioning before replacing.

Before replacing HVAC system components to improve energy efficiency, explore the possibility of HVAC system recommissioning. Recommissioning is essentially the same process as commissioning, but it is applied to a building's existing HVAC, controls, and electrical systems (U.S. EPA, 2008).

*Commissioning* is the process of verifying that a new building functions as intended and communicating the intended performance to the building management team. This usually occurs when a new building is turned over for occupancy. In practice, commissioning costs are not included in design fees and often compete with other activities, so commissioning is seldom pursued properly. To ensure that energy performance and operational goals are met, however, the building must be commissioned. To achieve this, ENERGY STAR recommends the following:

- Communicate your energy performance goals during commissioning to ensure that the design target is met. Encourage energy use tracking so that performance comparisons are made over time.
- Specify detailed commissioning activities in project contracts. Seek separate funding for commissioning work, to ensure that it will get done and be done well.
- Hire building commissioning experts. Include the commissioning firm as part of the design team early in the project.
- Finalize and transfer a set of technical documents, including manufacturers' literature for systems and components. Supplement technical literature with summaries of how to operate and manage the systems. Provide additional explanation for innovative design features.

*Recommissioning* involves a detailed assessment of existing equipment performance and maintenance procedures. This is compared to the intended or design performance and maintenance procedures to identify and fix problem areas that might be hampering building energy efficiency. Recommissioning can be a cost-effective retrofit sometimes generating more savings than the cost of the retrofit measure. For example, recommissioning may help avoid the need to install new or additional equipment, leading to savings in capital investments.

The U.S. EPA's ENERGY STAR Building Upgrade Manual (U.S. EPA, 2008) recommends a stepwise approach to recommissioning, in which a series of strategically ordered building "tune up" strategies are pursued. First, lighting and supplemental loads should be assessed, then the building envelope, followed by controls, testing, adjusting and balancing, heat exchange equipment, and finally heating and cooling systems. Most of these steps relate to HVAC system components or factors that will directly affect HVAC system energy consumption (such as building envelope and lighting). For more information, consult the manual.

### Install energy monitoring and control systems.

An energy monitoring and control system supports the efficient operation of HVAC systems by monitoring, controlling, and tracking system energy consumption. Such systems continuously manage and optimize HVAC system energy consumption while also providing building engineers and energy managers with a

valuable diagnostic tool for tracking energy consumption and identifying potential HVAC problems. Several projects indicate that the average payback period for HVAC control systems is about 1.3 years.

### **Adjust non-production setback temperatures.**

Setting back building temperatures (i.e. adjusting building temperatures down in the winter or up in the summer) during periods of non-use, such as weekends or non-production times, can significantly reduce HVAC energy consumption.

### **Repair leaking ducts.**

Leaking air ducts can waste significant amounts of energy. Install duct insulation and perform regular duct inspection and maintenance, including ongoing leak detection and repair. According to a study by Lawrence Berkeley National Laboratory, repairing duct leaks in industrial and commercial spaces can reduce HVAC energy consumption by up to 30%. The study also showed that duct tape should not be used for leak repair; aerosol sealants are preferred.

### **Consider variable air volume systems.**

Variable-air-volume systems adjust the rate of air flow into a room or space based on the current air flow requirements of that room or space. Variable-air-volume systems therefore work to more closely match HVAC load to heating and cooling demands, which reduces energy use.

### **Install adjustable speed drives (ASDs).**

Adjustable speed drives can be installed on variable-volume air handlers and recirculation fans to match precisely the flow and pressure requirements of air handling systems. Energy consumed by fans can be lowered considerably since they do not constantly run at full speed. Adjustable speed drives can also be used on chiller pumps and water systems pumps to minimize power consumption based on system demand.

### **Consider heat recovery systems.**

Heat recovery systems reduce the energy required to heat or cool facility intake air by recovering the thermal energy of the exhaust air. Common heat recovery systems include heat recovery wheels, heat pipes, and run-around loops. Heat pipes recover about 45 to 65% of the exhaust heat, while the efficiency of run-around loops can be in the 55 to 65% range.

### **Modify your fans.**

Changing the size or shape of the sheaves of a fan can help to optimize fan efficiency and airflow, reducing energy consumption. Toyota optimized the sheaves of its fans instead of installing adjustable speed drives (ASDs) on fans, finding better savings and payback periods than expected.

### Use ventilation fans.

Ventilation fans installed in the ceilings of work areas can help destratify workspace air, leading to better circulation of cool air in summer and warm air in winter, as well as more even temperature distributions from floor to ceiling. Such fans can help reduce the load on building heating systems by helping to “push down” warm air that rises during heating months.

### Install efficient exhaust fans.

Exhaust fans are standard components in any HVAC system. Mixed flow impeller exhaust fans offer an efficient alternative to traditional centrifugal exhaust fans. They are typically 25% more efficient than centrifugal fans and can be cheaper to install and maintain. The expected payback period is about two years (Tetley, 2001).

### Add building insulation.

Adding insulation will reduce utility bills. Older buildings are likely to use more energy than newer ones, leading to very high heating and air conditioning bills. However, even in new buildings, adding insulation may reduce utility bills enough to pay for itself within a few years.

Various states have regulations and guidelines for building insulation—for example, California’s [Energy Efficiency Standards for Residential and Nonresidential Buildings \(Title 24\)](#). Going beyond regulated insulation levels may be economically beneficial and should be considered as part of a new building’s design, as well as for reconstruction of existing buildings. For refrigerated warehouses, much higher levels of insulation are preferred.

### Employ solar air heating.

Solar air heating systems, such as Solarwall<sup>®</sup>, use conventional steel siding painted black to absorb solar radiation for insulation. Fresh air enters the bottom of the panels where it is heated as it passes over the warm absorber, and fans distribute the air. Using this technology, the Ford Motor Company’s Chicago Stamping Plant turned its south wall into a huge solar collector (CREST, 2001). Energy savings were estimated to be over \$300,000 per year compared to conventional natural gas air systems. Capital costs were \$863,000 (about \$15 per square foot, including installation), resulting in a payback period of less than three years. In addition to energy savings, the system was reported to provide clean fresh air for employees. This measure is best applied in cold climates; potential benefits must be analyzed for each site’s local conditions.

### Modify building reflection.

*Reflective roofing.* Use of a reflective coating on the roof of buildings in sunny, hot climates can save on air conditioning costs inside. Using reflective roofs, two medical offices in Northern California reduced air conditioning demand; one by 8% and the other by 12%. For colder climates, the heat lost due to cool roofs (in winter, for example) needs to be considered, as it could negate savings. In addition to location and weather, other primary factors (such as roof insulation, air conditioning efficiency, and building age) also influence energy savings. Reflective roof materials are available in different forms and colors.

*“Green” roofs.* Roof gardens on a flat roof improve the insulation of buildings against both hot and cold by providing heat in winter and air conditioning in summer. In winter, “green” roofs can freeze, so they carry a slight heating penalty but still often yield net energy savings. In addition, a roof garden can increase the lifetime of the roof, reduce runoff to local storm drains, and lower air pollution and dust.

*Shading and windbreaks.* Shade trees reduce the need for cooling in hot climates. Shade trees should be deciduous (providing shade in the summer and none in the winter) and planted on the west and southwest sides of the building (based on the path of the summer sun). Trees planted on the north side of the building in cold climates can reduce heating in winter by shielding the building from the wind. Vines can provide both shade and wind shielding.

### **Install low-emittance (Low-E) windows.**

Low-emittance windows are another effective strategy for improving building insulation. Low emittance windows can lower the heat transmitted into a building to increase its insulating ability. There are two types of Low-E glass: high solar transmitting (for regions with higher winter utility bills) and low solar transmitting (for regions with higher summer utility bills). The U.S. DOE supports the development of new window and glazing technology. The ENERGY STAR website includes a selection of rated Low-E windows. New window and glazing technology is being developed worldwide (see for example [www.efficientwindows.org](http://www.efficientwindows.org)).

## Energy Efficiency Technologies for Ammonia Production

There is a big variety of energy efficiency measures that can yield substantial cost savings, while at the same time increase or maintain plant throughput and in certain cases improve product quality. The following eight chapters describe measures/technologies that can be implemented in ammonia plants. It should be noted that the mentioned energy and feedstock savings vary from plant to plant, as they are dependent on plant capacity, configuration, and operating conditions. Where available, case studies that present the results of specific measures, achieved cost savings, and payback periods are discussed.

## Chapter Eleven: Steam Reforming Process (natural gas)

In this chapter:	
Install adiabatic pre-reformer	Retrofit with heat exchanger reformer
Heat exchange autothermal reforming	Recover reformer flue gas heat
Increase mixed feed preheat temperature	Insulate reformer furnace
Increase reformer operating pressure	Lower reformer S/C ratio
Shift reformer duty	Use improved catalyst designs for primary reforming
Use improved catalyst designs for secondary reforming	Use improved materials for reformer tubes
Improve design of secondary reformer burner	Use improved arch seals at the primary reformer
Install a feed-gas saturator	Install natural gas expansion turbine

### Best Practices for Energy-Efficient Steam Reforming

- **Install adiabatic pre-reformer.** When excess steam is available, install a pre-reformer that utilizes waste heat to partially reform the feed and decrease the energy use or increase the production capacity.
- **Retrofit with heat exchanger reformer.** When alternative energy sources are available and natural gas supply is limited, expensive, or uncertain, use a heat exchanger reformer to increase the front-end capacity.
- **Heat exchange autothermal reforming.** New ammonia plants can install autothermal reforming that eliminates the use of the traditional fuel-fired primary reformer, however extra energy might need to be imported to drive mechanical equipment.
- **Recover reformer flue gas heat.** Use the low-level heat from the reformer flue gases to preheat combustion air, produce low pressure steam or preheat the boiler feed water and save energy.
- **Increase mixed feed preheat temperature.** Extend feed gas preheating to decrease the duty of the radiant section and save energy.
- **Insulate reformer furnace.** Insulate the reformer with new fiber materials with low thermal conductivity and heat storage, and reduce the energy use by up to 5%.
- **Increase reformer operating pressure.** Increase the reformer pressure to lower the steam needs at the synthesis gas compressor and save energy.
- **Lower reformer steam to carbon ratio.** Apply several revamp measures in the shift conversion and the CO<sub>2</sub> removal section to be able to lower the steam-to-carbon ratio and reduce the energy use.



- **Shift reformer duty.** By increasing the firing and supplying more process air to the secondary reformer, the same degree of reforming is achieved as in conventional reforming while energy use decreases by 2%.
- **Use improved catalyst designs for primary reforming.** Use catalysts with improved shape and size to increase throughput and decrease pressure drop.
- **Use improved catalyst designs for secondary reforming.** Use catalysts with improved designs to enhance activity and reduce the catalyst volume to save energy.
- **Use improved materials for reformer tubes.** Use micro-alloyed tubes with minimum wall thickness to increase catalyst volume, increase firing, and lower the pressure drop.
- **Improve design for secondary reformer burner.** Use improved secondary burner designs for more efficient mixing and reduce energy consumption.
- **Use improved arch seals at the primary reformer.** Use improved seals for catalyst tube penetration at the radiant section and save energy by eliminating heat losses.
- **Install a feed-gas saturator.** Use the low-level heat from the flue gases to saturate the natural gas-feed and save energy.
- **Install natural gas expansion turbines.** Install expansion turbines to use the pressure drop of the natural gas used as feedstock in the reformer to generate electricity.

### Install an adiabatic pre-reformer.

When excess steam is available at a plant, a pre-reformer can be installed at the reformer section. Adiabatic steam pre-reforming uses a highly active nickel catalyst to partially reform a desulfurized hydrocarbon feed, using waste heat from the convection section of the reformer. The use of waste heat lowers the steam production in the convection section of the reformer furnace, reducing the primary reformer duty and hence gas consumption. The adiabatic pre-reformer is used in the steam reforming production route upstream of the primary reformer, and can be added to existing plants with excess steam production. Energy consumption can be reduced by 4-10% by installing an adiabatic pre-reformer (IPTS/EC, 2007). In general, the installation of a pre-reformer can reduce the size of the primary reformer by up to 25% (Haldor Topsoe, 2007). The technology can also be used to increase the production capacity at no additional energy costs. Installing a pre-reformer at an existing plant will typically increase production by 10-20% (Worrell and Galitsky, 2005; Abrardo and Khuruna, 1995; Munch et al., 2007). Other benefits of the technology include the increased flexibility in terms of feedstock for the steam reformer and the increased lifetime of the steam reformer and shift catalysts, as practically all sulfur in the hydrocarbon feed and process steam is absorbed by the pre-reforming catalyst (Haldor Topsoe, 2011a; Patel et al., unknown date). Various suppliers provide pre-reformers, including Haldor-Topsoe, Süd-Chemie, and Technip-KTI.

**CASE STUDY:** The (former) Kemira Oy ammonia plant in Rozenburg, the Netherlands, installed an adiabatic pre-reformer. Energy savings were about 4% at a payback period between 1 and 3 years (Worrell and Blok, 1994).

### Retrofit with heat exchanger reformer.

The reformer exchanger uses high temperature process heat exiting the secondary reformer (or auto-thermal reformer) to produce syngas by reforming an additional flow of natural gas and steam. In this way, additional reforming capacity is realized by utilizing heat available in the existing unit that was previously used for steam generation. As the process gas heat is used for hydrogen production instead of steam generation, the hydrocarbon consumption and steam export per unit hydrogen produced is reduced (Haldor Topsoe, 2011a; Singh and Price, 2011). Figure 3 shows the KBR Reforming Exchanger System (KRES) heat exchanger used for increasing the front-end production. The use of a heat exchanger reformer can provide a low cost retrofit solution to ammonia plants that have either an expensive, limited or uncertain supply of natural gas, but have alternative energy sources available.

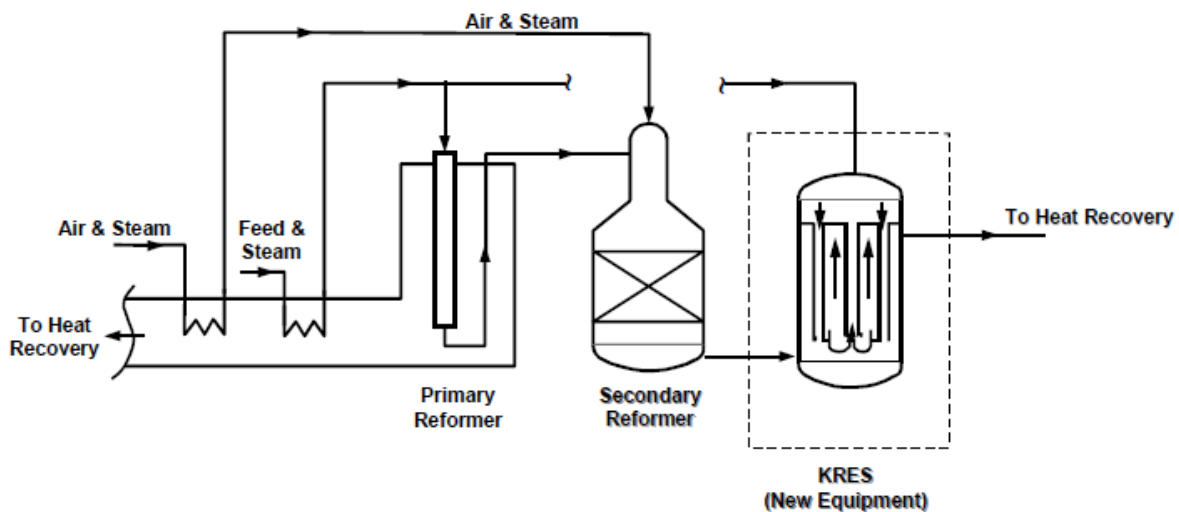

Figure 3: KRES for increasing front-end production (Malhotra and Knez, 2002).

**CASE STUDY:** The adoption of the KRES technology at an Indian plant increased syngas production by 30% and improved the overall efficiency of the ammonia plant. It also improved the performance of the old reformed gas waste heat boiler by reducing its inlet temperature and thus reducing the thermal and mechanical stresses. Also, shift converter conditions were improved because of the lower boiler outlet temperatures. The installation of the KRES-ES technology reduced natural gas consumption from 28.9-37.6 MMBtu/ton NH<sub>3</sub> to 25.2 MMBtu/ton NH<sub>3</sub> (30.6-39.8 GJ/tonne NH<sub>3</sub> to 26.6 GJ/tonne NH<sub>3</sub>). The reduced fuel consumption may however be partially offset by additional oxygen and steam production (Singh and Price, 2011).

Another example of heat exchanger reformer is the Haldor Topsoe Exchange Reformer (HTER-p). The operating conditions of the HTER-p can be adjusted independently of the primary reformer to get the optimum performance of the whole reforming unit. About 20% of the natural gas feed can be reformed in this heat exchanger reformer and in this way by-pass the primary reformer. By introducing the HTER-p technology, an increase in reforming capacity of 25% can be achieved. The capacity increase could also be translated into an unchanged capacity and a correspondingly smaller load on the primary reformer (Haldor Topsoe, 2007). The use of the heat exchanger reformer for capacity increase can be implemented as a retrofit in existing ammonia plants.

**CASE STUDY:** The HTER-p is in commercial operation at a synthesis gas plant in South Africa since 2003, where it is placed downstream of an auto-thermal reformer. The revamp with the HTER-p resulted in a capacity increase of 33% (Haldor Topsoe, 2007).

**CASE STUDY:** In 2003, the Liaohoe ammonia plant in China that operated a conventional steam reformer, replaced the fired primary reformer with a heat exchanger reformer (the KRES) and decreased its energy use from 36.2 MMBtu/ton NH<sub>3</sub> to 34.0 MMBtu/ton NH<sub>3</sub> (38.3 GJ/tonne NH<sub>3</sub> to 35.9 GJ/tonne NH<sub>3</sub>) (Malhotra et al., 2004).

### Heat exchange autothermal reforming.

Thermodynamically, it is wasteful to use the high temperature ~1,800 °F (~1,000°C) gases exiting the secondary and the primary reformer to produce steam. It is more favorable to utilize the heat from the secondary reformer gases in a new type of primary reformer, the heat exchanger reformer, and thus eliminate the use of the traditionally fuel-fired reformer furnace (IPTS/EC, 2007). When a heat exchanger is used, more oxygen needs to be supplied to the secondary reformer. Autothermal reforming (elimination of the fuel-fired primary reformer) can only be applied in new plants.

There are several processes that operate without a fired primary reformer in an advanced configuration such as the ICI LCA and the KBR KAAPplus processes. Other characteristics of these advanced processes

are isothermal shift conversion, high activity synthesis catalysts and CO<sub>2</sub> removal systems with a solid absorbent. Figure 4 shows the KBR Reforming Exchanger System (KRES) process, in which the natural gas stream is split into two streams after the desulfurization unit. The smaller of the two streams enters the heat exchanger and the other an autothermal reformer. The LCA and the KAAPplus processes drastically decrease CO<sub>2</sub> emissions as they eliminate the flue gases from the primary reformer and may also decrease NO<sub>x</sub> emissions by 50% or more (IPTS/EC, 2007). The KRES technology is in commercial operation at ammonia plants in Kitimat (Canada) since 1994 and Liaohe (China) since 2003.

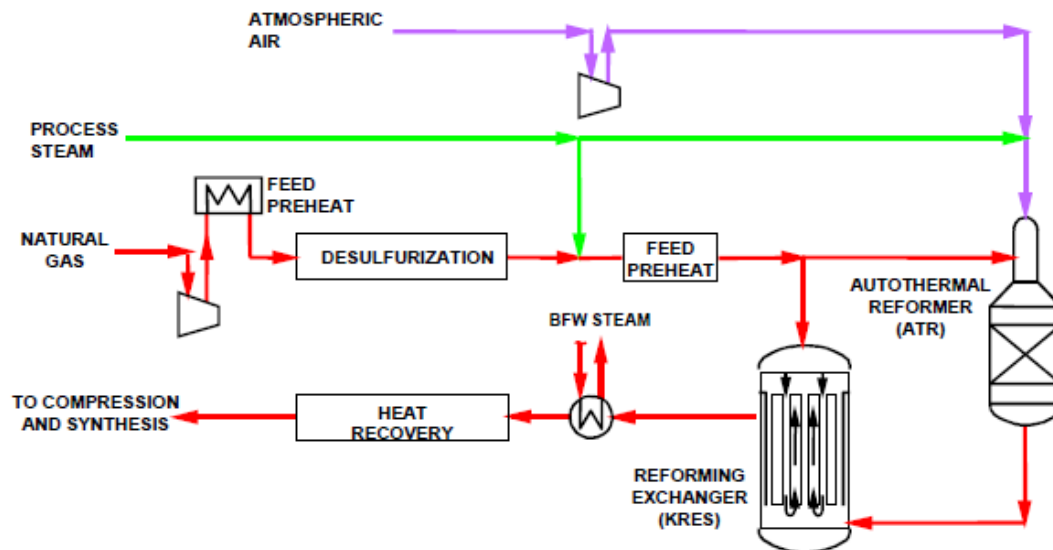

Figure 4: The KRES (Kellogg reforming exchanger KRES) process - parallel stream (Malhotra and Knez, 2002).

The overall energy consumption is claimed to be 27.7 MMBtu/ton NH<sub>3</sub> (29.3 GJ/tonne) for the ICI LCA process and 25.7 MMBtu/ton NH<sub>3</sub> (27.2 GJ/tonne) for the KBR KAAPplus process; according to the IPTS/EC (2007), extra energy may need to be imported to drive the mechanical equipment, making the net energy use for the heat exchange autothermal reforming processes about 30.1 MMBtu/ton NH<sub>3</sub> (31.8 GJ/tonne). According to the Japan Chemical Industry Association, such a configuration can reduce energy use in the primary reformer by about 10%.

### Recover reformer flue gas heat.

Low level heat from the reformer flue gases can be recovered and used for the preheating of combustion air, low pressure steam production, or preheating of boiler feed water or demineralized water. For this, additional heat recovery surface area is installed in the convection zone of the reformer furnace (Christensen, 2001b; Nand and Goswami, 2009). The energy savings obtained from introducing combustion air preheating are due to reduced fuel consumption in the primary reformer. Introduction of low pressure steam production or preheating of process water results in heat savings and is generally a simpler solution than combustion air preheating. Reducing the stack temperature by 180°F (100°C) will result in energy savings of approximately 0.16-0.4 MMBtu/ton NH<sub>3</sub> (0.17-0.4 GJ/tonne NH<sub>3</sub>) (Christensen, 2001b, Nand and Goswami, 2009).

### Increase mixed feed preheat temperature.

About half of the heat released by the burners is used by the reformer tubes. The remaining heat is carried by the flue gases that leave the radiant section of the reformer and is recovered by the convection coils to preheat other process streams (IPTS/EC, 2007). When the flue gas temperature is considerably reduced, the flue gases are released into the atmosphere. The heat requirements of the radiant section determine the overall fuel consumption of the furnace. By decreasing the duty of the radiant section by extended preheating of the reformer feed gas before it reaches the catalyst tubes, the overall fuel consumption can be decreased (OPET Network, 1998).

An ammonia plant in the Netherlands installed new highly alloyed mixed feed preheat coils in the convection section of the furnace to extensively preheat the feed/gas mixture. As the radiant heat was substituted by the heat available in the convection section the duty of the radiant section decreased, achieving a reduction in fuel use (OPET Network, 1998). Redesigning the convection section will typically result in lower steam generation. To optimize the energy efficiency improvements, this concept needs to be combined with a reduction in steam use (i.e., lower steam/carbon ratio, improved efficiency steam turbine). Energy savings are estimated at 0.3-0.7 MMBtu/ton NH<sub>3</sub>.

### Insulate reformer furnace.

In most heat generation equipment, heat losses occur due to the convection and radiation of energy from the system to the environment. This heat loss depends on the outside temperature and can cause a significant reduction in process heating efficiency. Insulating materials such as bricks and refractories are essential to minimize heat losses. Significant improvements in process heating efficiency can be achieved by using new refractory fiber materials with low thermal conductivity and heat storage. Typical applications include the installation of furnace covers, installing fiber liner between the standard refractory lining and the shell wall, or installing ceramic fiber liner over the present refractory liner. Replacing standard refractory linings with vacuum-formed refractory fiber insulation will also reduce heat losses. Insulating the reformer furnace can reduce the energy use by up to 5% (U.S. DOE, 2008b).

**CASE STUDY:** An energy efficiency assessment of an Australian ammonia plant recommended a new refractory coating that could be used to improve the efficiency of the furnace. A preliminary analysis suggested energy savings of 63 GBtu (60 TJ) per year and a reduction in GHG emissions of around 3,300 tons CO<sub>2</sub>e per year. The payback period is expected to be just over a year (Australian Government, 2009).

### Increase reformer operating pressure.

Preheated feedstock and high pressure steam (3-4 MPa) enter at the top of the primary reformer. The reformer pressure can be optimized by measuring the pressure profile, determining how close it is to the relief valve design capabilities, and reviewing potential opportunities to raise it. When older equipment is in use, relief valves can be retrofitted to allow for a different pressure setting that is still safe for the equipment. By increasing the reformer pressure the need for compression at the synthesis gas compressor is reduced, resulting in lower steam use in steam driven compressors and more steam available to other units. Fuel is saved in the balancing boiler by 0.1-0.2 MMBtu/ton NH<sub>3</sub> (A2A Toolkit).

### Lower reformer steam to carbon ratio.

Reducing the steam/carbon ratio results in energy savings due to reduced heat input to the primary reformer as well as steam savings. In addition, it will lower the pressure drop, resulting in energy savings in the synthesis gas compressor. The optimum steam to carbon ratio is typically around 3.0, although the feedstock quality, purge gas recovery, primary reformer capacity, shift operation, and the plant steam balance are factors that may influence the actual optimum steam/carbon ratio in a specific facility (Christensen, 2001b; IPTS/EC, 2007; Nand and Goswami, 2009).

Typically, the minimum allowable steam to carbon ratio is determined by requirements set by the shift section. With the use of Cu-promoted High Temperature Shift (HTS) catalysts the permissible steam to carbon ratio can be reduced to 2.8. The heat requirements in the CO<sub>2</sub> removal section can hinder the reduction of the steam to carbon ratio. Several revamp measures (i.e. change the packing materials in the tower, use enhanced CO<sub>2</sub> removal solvents) can be applied to decrease the energy use in the CO<sub>2</sub> removal section.

In new plants, the steam/carbon ratio may be lower than 3.0. Lowering the steam/carbon ratio in an older plant from 4 to 3 will result in savings of 0.8 MMBtu/ton NH<sub>3</sub> (Christensen, 2001b).

### Shift reformer duty.

In natural gas or naphtha based steam reforming, the use of excess air in the secondary reformer shifts some of the reforming load from the primary to the secondary reformer. The reduction of primary reforming is achieved by decreasing heat supply. By increasing the internal firing and supplying more process air (process air requirement is up to 50% higher than in conventional reforming) in the secondary reformer, the same degree of reforming is achieved as in conventional reforming. The lower operating temperature reduces the energy consumption of the primary reformer by about 6% and overall energy consumption by about 2%. At the same time the lifetime and efficiency of the catalysts and reformer tubes is increased (Ravi et al., 1989; UNEP, 1998).

Examples of processes that employ reduced primary reforming in combination with surplus process air in the secondary reformer are the Braun Purifier, the ICI AMV, the Foster Wheeler AM2, the Humphreys and Glasgow BYAS, the Montedison Low-pressure, the Kellogg's LEAP process and the Jacobs Plus Ammonia Technology. In some of these processes (such as the Foster Wheeler M2 and the Humphreys & Glasgow BYAS) part of the desulfurized feed-gas bypasses the primary reformer and directly enters the secondary reformer. In some cases, excess nitrogen is removed with the use of cryogenics after the methanation process. The energy use for processes with reduced primary reforming and increased air surplus in the secondary reformer ranges between 25.4-27.7 MMBtu/ton NH<sub>3</sub> (26.8 and 29.3 GJ/tonne) (Ullman's, 2011). However, energy use for compression will increase due to the higher need for process air in the secondary reformer (IPTS/EC, 2007). This technology is only applicable to new plants.

### Use improved catalyst designs for primary reforming.

The reformer is composed of many tubes filled with a catalyst (usually nickel-based). Natural gas passes through the catalyst filled tubes to produce H<sub>2</sub>, CO and CO<sub>2</sub>. The reaction takes place on a thin area around the surface of the catalyst modules. By adjusting the shape of the catalyst so that the Geometric Surface

Area (GSA) per unit volume is increased, catalyst activity can be improved. Also, by adjusting the shape of the catalyst modules, the Heat Transfer Coefficient (HTC) can increase due to improved catalyst packaging and better contact with the wall tubes. The use of improved catalyst designs with increased module voidage and/or size will also lower the pressure drop (Beyer et al., 2005).

By improving the shape and the size of the catalyst, the tube side heat coefficients for a target pressure drop can be improved by 20-40% (Malhotra and Knez, 2002). A combination of multiple catalyst sizes can also be used, with the larger modules being used in the lower part of the tubes where the major part of pressure drops take place (Topsoe, unknown date). The main benefits from using improved catalyst designs are improved throughput and lower pressure drops. The energy savings are up to 0.2 MMBtu/ton  $\text{NH}_3$ .

### Use improved catalyst designs for secondary reforming.

Like the catalysts in primary reformers, the use of high surface area catalysts in the secondary reformer will result in improved activity. Since the reaction in the secondary reformer is adiabatic, improved heat transfer is not required. In past years, the increase in Geometric Surface Area (GSA) has resulted in significant increases in space velocities. The outcome was up to 50% shorter loading catalyst volumes and a bigger area above the catalyst bed in which the reaction can take place (Beyer et al., 2005). Reducing the catalyst volume produces energy savings up to 0.3 MMBtu/ton  $\text{NH}_3$ . The use of lower catalyst volumes has allowed the construction of smaller secondary reformers and a decrease in pressure drop (Beyer et al., 2005).

### Use improved materials for reformer tubes.

The reformer contains about 200-400 tubes made of chromium nickel steel, 32-43 feet long (10-13 meters), with an inner diameter of 3-5.5 inch (75-140 mm) and a wall thickness of 0.4-0.7 inch (11-18mm) (Ullmann's, 2011). Under the severe conditions present in the reformer, the tubes start to creep and rupture. The deformation is the result of internal pressure and tube-wall temperature. To avoid tube rupture, lower pressures are employed, leading to higher power use for compression in ammonia synthesis. The standard material for many years was the HK 40. The HP modified (1.5% Nb) material, due to its improved temperature properties (40 bar reforming pressure at a tube wall temperature of 1,650°F (900°C)), has been used in many tube replacements and as tubes in new plants. The use of micro-alloys containing Ti and Zr are another improvement, permitting reduction of tube-wall thickness while maintaining the same tube lifetime (100,000 hours). By installing tubes with smaller wall thickness and/or wider diameter the capacity of the front end of an ammonia plant can be increased (Beyer et al., 2005). The use of micro-alloyed tubes with minimum wall thickness can be used to increase the catalyst volume, increase firing and lower the pressure drops. Energy savings are estimated at 0.2-0.4 MMBtu/ton  $\text{NH}_3$ .

**CASE STUDY:** An Indian plant replaced the reformer tubes with modified HP-Nb materials stabilized with micro-alloys. The benefits were reduced tube-wall thickness from 20mm to 10mm. The increased inner tube diameter resulted in a 35% increase of the catalyst volume, an increase of plant capacity of 15%, and reduced tube skin temperature. Overall energy use decreased by 0.6 MMBtu/ton  $\text{NH}_3$ . The payback period was 40 months (PCRA, unknown date).



### Improve design of secondary reformer burner.

Efficient mixing of the process gas and air (or oxygen) is a critical parameter for secondary reformer performance. Uneven mixing can result in large temperature variations above and into the catalyst bed. This causes variations in the degree of methane reforming achieved and results in a poor overall approach to reforming equilibrium, even when a highly active secondary reforming catalyst is used. An improved approach to achieve reforming equilibrium results in improved yields and reduces plant energy consumption by reducing the requirement for inerts purging from the synthesis loop. The efficiency of gas mixing is primarily a function of the burner design. A poorly designed burner can, besides inefficient gas mixing, also damage vessel walls, refractories, or even the burner itself (Haldor Topsoe, 2011b). Various suppliers offer improved designs for the secondary reformer burner and energy savings are up to 0.2 MMBtu/ton NH<sub>3</sub> (A2A Toolkit).

### Use improved arch seals at the primary reformer.

The radiant section operates under a vacuum. Poorly sealed openings for catalyst tube penetration at the top of the radiant zone can cause excessive energy losses. Cold ambient air induced into the flue degrades the heat and increases fuel use. Improved seals allow for thermal movement of the tubes without degrading the closure. Energy savings are estimated to be up to 0.3 MMBtu/ton NH<sub>3</sub> (A2A Toolkit).

**CASE STUDY:** In the hydrogen plant of the Numaligarh Refinery Ltd. in India, significant heat losses were identified at the reformer tubes. By installing improved seals, a considerable reduction in wasted heat was achieved. The surface temperature of the tube decreased from 1,022°F (550°C) to less than 662°F (350°C). Heat loss was reduced by 1.7 MMBtu/hour, resulting in fuel savings of 660 MMBtu/year (Insulcon, unknown date).

### Install a feed-gas saturator.

Feed gas composed of steam and natural gas with a volumetric ratio of steam to carbon of about 3.5 to 1 is reacted in the primary reformer. The steam is generated from recovered waste heat and auxiliary boilers. By installing a feed-gas saturator, the low-level heat from the flue gases that otherwise would be lost, can be used to saturate the natural gas feed. This will result in extra steam generation that can replace part of the steam generated in the boiler, resulting in increased availability of medium pressure steam. The energy savings can range between 0.3 and 1.0 MMBtu/ton NH<sub>3</sub> (UNEP, 1998; A2A Toolkit). The water used for feed-gas saturation is process condensate that may contain some methanol and ammonia.

### Install natural gas expansion turbines.

Natural gas used for feedstock and fuel may be supplied to the ammonia plant at or near the pressure that is needed for the ammonia process. About 20-40% of the natural gas supplied is used as reformer fuel and requires significant lower pressures. Expansion turbines can be installed to use the pressure drop and be coupled to a power generator or a cooling water pump. Lehman and Worrell (2001) describe the use of expansion turbines that capture the energy from high-pressure gas transmission. These turbines use the pressure drop when natural gas from high-pressure pipelines is decompressed for local networks

to generate power, utilizing otherwise unused pressure in the natural gas grid. Gas is transmitted at high pressures, from 200 to 1500 psi (14 to 100 bar). A typical pressure for gas entering a turbine is 580 to 1020 psi, with an exit pressure (back pressure) of 70 to 150 psi (5-10 bar) (Lehman and Worrell, 2001). Gas generally enters an expansion turbine at ambient temperature, and expansion from this temperature leaves gas too cold for further transmission upon exiting the expansion turbine. This necessitates heating the gas just before or after expansion. The heating is generally performed with either a CHP unit, or a nearby source of waste heat. For power recovery applications, turbines are generally rated from 150 kW to 2,500 kW (Lehman and Worrell, 2001), and energy savings in an ammonia plant are estimated at 0.1-0.3 MMBtu/ton NH<sub>3</sub>.

## Chapter Twelve: Shift Conversion Process

In this chapter:	
Isothermal CO converter	Axial-radial flow converter
Use improved catalysts in shift process	Apply low pressure drop design for shift converter
Use low temperature shift (LTS) guard with waste heat recovery	Consider the Selectoxo process for final purification

### Best Practices for Energy-Efficient Shift Conversion

- **Isothermal CO converter.** Replace the adiabatic reactor with an isothermal reactor and generate medium pressure steam.
- **Axial-radial flow converter.** Use axial-radial flow converters to increase conversion efficiency and reduce pressure drop, thereby saving energy for compression.
- **Use improved catalysts in shift process.** Use improved catalysts in both steps of shift conversion and reduce energy consumption.
- **Apply low pressure drop design for shift converter.** Improve the internals in catalyst vessels and reduce pressure drop, thereby decreasing energy use and/or increasing plant throughput.
- **Use low temperature shift (LTS) guard with waste heat recovery.** Install an additional LTS guard reactor before the LTS unit to reduce feedstock use and lower the steam requirements.
- **Consider the Selectoxo process for final purification.** Add Selective Catalytic Oxidation (Selectoxo) after the LTS converter to improve the efficiency by significantly reducing the CO slippage.

#### Isothermal CO converter.

The process gas exiting the secondary reformer contains approximately 10-15% CO (dry gas base). In the water-gas-shift reactor, CO is converted to CO<sub>2</sub> and H<sub>2</sub>. In conventional plants, this conversion takes place in an adiabatic CO reactor. The conversion is conducted at two temperatures; the high temperature conversion (660-716°F (350-380°C)) using a Fe-Cr catalyst and the low temperature conversion (390-430°F (200-220°C)) using a Cu-Zn catalyst. After the conversion, the residual CO content of the process gas is about 0.2-0.4%.

In an isothermal reactor, the conversion can be conducted in a single step at about 480°F (250°C) with the use of a special copper-based catalyst. The conversion is achieved isothermally by continuously removing heat from the catalyst bed with the use of cooling tubes (IPTs/EC, 2007). In a single step the isothermal reactor allows conversion to 0.7% CO (dry basis). The heat from the reaction is recovered by generating medium pressure steam in an integrated heat exchanger. The energy savings are estimated at 0.4 MMBtu/ton NH<sub>3</sub>. The payback period is about 0.2-0.5 years.

### **Axial-radial flow converter.**

In conventional shift converter designs, the process gas travels axially through the catalyst bed. In contrast, in axial-radial flow converters, the process gas travels axially and radially through the catalyst bed. This results in increased conversion efficiency and reduced pressure drops through the process. Energy savings of up to 1.4 MMBtu/ton NH<sub>3</sub> (1.5 GJ/tonne) can be achieved due to lower gas compression requirements upstream of the converter.

### **Use improved catalysts in shift process.**

Improved high temperature shift (HTS) catalysts with additional copper promotion can avoid the production of by-products (methane and hydrocarbons) allowing for lower steam-to-carbon ratios in the reforming process. Improved low temperature shift (LTS) catalysts can operate at lower temperatures to achieve even lower residual CO content and low by-product production (methanol) (Ullmann's, 2011). This measure is only applicable to ammonia plants employing a two stage shift conversion. The use of improved catalysts in shift conversion will reduce energy use by about 0.05-0.09 MMBtu/ton NH<sub>3</sub>.

### **Apply low pressure drop design for shift converter.**

By improving the internals in catalyst vessels, the way the inlet gas is distributed inside the catalyst and the way the exit gas is collected at the end of the catalyst bed are improved. In this way, the pressure drop across the catalyst can be reduced. Reduced pressure drop can reduce energy use and/or increase the plant throughput. With the use of Computational Fluid Dynamics (CFD) and other advanced techniques, the design of internals has been significantly improved, resulting in energy savings of up to 0.2 MMBtu/ton NH<sub>3</sub>.

### **Use low temperature shift (LTS) guard with waste heat recovery.**

The installation of an additional Low Temperature Shift (LTS) guard reactor before the LTS can reduce the CO slippage without increasing the pressure drop. The CO slippage can be reduced from about 0.25-0.30% to about 0.10-0.15%. A lower CO slippage results in increased ammonia production, as less hydrogen will be consumed in the methanator to convert the carbon oxides into inert methane. This will result in reduced feedstock use, and lower steam requirements (CDM, 2004). The temperature in the LTS converter can be better controlled and the waste heat recovery can be improved with the installation of a boiler feed water preheater between the LTS guard and the LTS converter (CDM, 2004). Typical fuel savings are estimated at 0.08 MMBtu/ton NH<sub>3</sub> (FAI, 2013; Nand and Goswami, 2009).

### **Consider the Selectoxo process for final purification.**

For the conversion of CO into CO<sub>2</sub> and H<sub>2</sub>, most ammonia plants, use a combination of two shift conversion steps, a high temperature and a low temperature step. The CO content is decreased from about 10-12% (dry gas base) to approximately 0.2-0.4% (dry gas base) (IPT/EC, 2007).

An energy efficient option is to add the Selective Catalytic Oxidation (Selectoxo) process after the Low Temperature Shift converter. Compared to other oxidation processes, the Selectoxo provides improved energy efficiency as it significantly reduces the CO slip to about 0.03%, improves process flexibility, and increases the throughput when revamped. The plant throughput can be increased by 1.5-2.0% (Maxwell,

2004). To achieve selective oxidation, a precious metal catalyst is used at 104-275°F (40-135°C). The CO<sub>2</sub> formed adds only slightly to the load on the downstream CO<sub>2</sub> absorption system (Ullmann's, 2011).

## Chapter Thirteen: Gas Refining Process

In this chapter:	
High pressure water power recovery turbine	Use enhanced CO <sub>2</sub> removal solvents
Recover heat from solvent regeneration in CO <sub>2</sub> removal section	Pressure swing adsorption for product purification
Use two stage regeneration in CO <sub>2</sub> removal system	

### Best Practices for Energy-Efficient Gas Refining

- **High pressure water power recovery turbine (from the CO<sub>2</sub> removal process).** Replace the pressure-reducing valve with a high pressure water power recovery turbine that can make use of the pressure difference and reduce the energy use.
- **Use enhanced CO<sub>2</sub> removal solvents.** Use improved solvents for CO<sub>2</sub> removal and significantly reduce the energy consumption.
- **Recover heat from solvent regeneration in CO<sub>2</sub> removal section.** Recycle part of the heat from the regenerated solvent and reduce the requirements for regeneration steam.
- **Pressure swing adsorption (PSA) for product purification.** When a pure CO<sub>2</sub> stream is not of major importance, use a PSA system to reduce inerts in the synthesis gas and decrease the energy consumption.
- **Use two stage regeneration in CO<sub>2</sub> removal system.** By replacing the one-stage regeneration unit with a two-stage unit, improve the CO<sub>2</sub> absorption and decrease hydrogen use at the methanator and regeneration energy use.

#### High pressure water power recovery turbine (from the CO<sub>2</sub> removal process).

In the CO<sub>2</sub> removal process, a large quantity of absorbent liquid is supplied under pressure (about 30 kg/cm<sup>2</sup>) to the top of the absorbing column. This absorbent liquid removes about 15% (volume) of CO<sub>2</sub> contained in the gas coming from the reforming and the shift conversion processes. Instead of using a pressure-reducing valve to reduce the pressure before liquid is sent to the regenerating column, a high pressure water power recovery turbine can be installed that uses the pressure difference to drive the feed pump for the absorbent liquid. The installation of a power recovery turbine for absorbent liquid reduces energy consumption by 0.02 MMBtu/ton of ammonia (NEDO, 2008; Japan Chemical Industry Association, unknown date). The payback period of installing a power recovery turbine is about 4 years at Japanese natural gas prices, which are typically higher than in the U.S. (Japan Chemical Industry Association, unknown date).

### Use enhanced CO<sub>2</sub> removal solvents.

The CO<sub>2</sub> formed in the gasification process and the shift conversion process is generally removed by scrubbing with a solvent. Conventional CO<sub>2</sub> removal applies a chemical absorption method using an absorbing liquid. The solvents used in chemical absorption processes are mainly aqueous amine solutions, such as monoethanolamine (MEA), or hot potassium carbonate solutions. Capturing CO<sub>2</sub> with solvents requires mechanical energy to circulate the solvent and heat to regenerate the solution. An almost pure CO<sub>2</sub> stream is recovered (1.3-1.4 tons CO<sub>2</sub>/ton NH<sub>3</sub>), which is typically vented or can be used in other (industrial) processes, such as urea production (UNEP, 1998), or exported for other uses (e.g. enhanced oil recovery, soft drinks and dry ice manufacture). The energy consumption of the CO<sub>2</sub> removal system depends on the solvent used and the way the system is incorporated in the ammonia plant. It is affected by syngas purity and CO<sub>2</sub> recovery.

The solvent monoethanolamine (MEA) is widely used. It has some significant drawbacks including the considerable amount of energy required for regeneration. Improved solvents, which require less energy for regeneration of the solution, include the Benfield process (HiPure and LoHeat) and BASF's two-stage activated diethanolamine (aMDEA) (EFMA, 2000a; UNEP, 1998). Energy consumption of chemical CO<sub>2</sub> removal systems per ton of CO<sub>2</sub> captured is in the range of 2.3-3.2 MMBtu/ton CO<sub>2</sub> (2.4-3.4 GJ/tonne CO<sub>2</sub>) for MEA based solvents and can be as low as 0.9 MMBtu/ton for a two-stage aMDEA process (Kunjunny et al., unknown date). IPTS/EC (2007) reports that energy savings of 0.8-1.8 MMBtu/ton NH<sub>3</sub> (0.8-1.9 GJ/tonne NH<sub>3</sub>) are possible when using improved solvents. A potential additional advantage is that the reduction in energy consumption may allow a reduction in the steam-carbon ratio in the primary reforming section. Lower re-boiler duty also allows increasing the plant capacity without any modification of equipment (CEAMAG, 2009).

Conventional CO<sub>2</sub> removal applies chemical absorption. However, CO<sub>2</sub> can also be removed using physical absorption. Physical absorption processes use an organic solvent that absorbs CO<sub>2</sub> as a function of the partial pressure. The high CO<sub>2</sub> loadings result in low circulation rates and less utility costs (Kunjunny et al., unknown date). Physical absorption solvents typically used in ammonia production processes include glycol dimethylethers (Selexol) and propylene carbonate (IPTS/EC, 2007; EFMA, 2000a). Regeneration of the solution is performed by vacuum flashing and air stripping and consumes significantly less energy than in chemical absorption. The energy savings from the use of improved solvents for CO<sub>2</sub> recovery are about 1.3 MMBtu/ton NH<sub>3</sub> (1.4 GJ/tonne NH<sub>3</sub>), while the investments are estimated at \$3.7 per MMBtu saved.

Improved solvents for CO<sub>2</sub> removal can be applied to all new and existing ammonia plants. The type of removal process depends on the layout of the ammonia plant and the CO<sub>2</sub> requirements (e.g. purity) (IPTS/EC, 2007).



**CASE STUDY:** At the IFFCO Kalol ammonia plant (India), the CO<sub>2</sub> removal section was revamped in 1995 from chemical absorption shifting from MEA to aMDEA. Energy consumption reduced from 3.2 MMBtu/ton CO<sub>2</sub> (3.4 GJ/tonne CO<sub>2</sub>) for MEA to 2.4 MMBtu/ton CO<sub>2</sub> (2.5 GJ/tonne CO<sub>2</sub>) for aMDEA solution swap. The change in solvent used in the CO<sub>2</sub> removal section reduced reboiler duty by 21 MMBtu/hr and resulted in overall energy savings of 1.1 MMBtu/ton NH<sub>3</sub> (1.2 GJ/tonne NH<sub>3</sub>). The costs of the revamp totaled 1.25 million USD (Vaish and Patel, 2002). In 2005, the IFFCO Kalol ammonia plant revamped the CO<sub>2</sub> removal section again and installed a two-stage aMDEA process (UNFCCC, 2008).

### Recover heat from solvent regeneration in CO<sub>2</sub> removal section.

The use of solvents in the CO<sub>2</sub> removal section requires heat for the regeneration. Part of the heat used for regeneration can be directly recycled by flashing the solution into a multi-stage vessel and bringing the flashed steam back up to regenerator pressure. This can be done using a portion of the incoming regeneration steam in ejectors or the flashed steam can be mechanically recompressed for reuse. Recycling part of the heat from the regenerated solvent reduces the requirement for imported steam for regeneration. Energy savings are estimated to be 0.3-0.7 MMBtu/ton NH<sub>3</sub>.

### Pressure swing adsorption for product purification.

To reduce the amounts of inerts in the synthesis gas stream, a Pressure Swing Adsorption (PSA) system can be used. The PSA technology has the potential to replace the Low Temperature Shift (LTS) conversion section, the CO<sub>2</sub> removal section, the methanation section and, in some cases, the secondary reformer section. PSA technology uses molecular sieves as adsorbents in a series of vessels. Examples of processes using the PSA technology are the Jacobs Plus Ammonia Technology, the ICI LCA process, KTI PARC process and the Linde Ammonia Concept (LAC) process. In the Linde LAC process, the PSA section is the only purification step of synthesis gas.

This measure can be applicable to all ammonia plants for which the CO<sub>2</sub> stream is not of major importance. However, when a pure CO<sub>2</sub> stream is required, classical solvent scrubbing is used to recover the CO<sub>2</sub> (IPTS/EC, 2007). The energy savings are estimated at 0.8-0.9 MMBtu/ton NH<sub>3</sub>.

### Two stage regeneration in CO<sub>2</sub> removal.

It is possible to reduce the energy use in the CO<sub>2</sub> removal section by replacing the old one stage regeneration unit with a two stage Giammarco Vetrocoke (GV) or a two stage aMDEA unit for regenerating the CO<sub>2</sub> removal solvent (Nand and Goswami, 2009). In a two stage regeneration unit, the bulk of the solution is only partly regenerated, which is all that is required for the bulk of the absorption duty. The small portion of the solution that is completely regenerated is returned to a smaller section of the second stage CO<sub>2</sub> absorption column. The improved CO<sub>2</sub> absorption decreases hydrogen consumption during methanation and reduces energy use in the regenerators. Energy savings may be as high as 1.0 MMBtu/ton NH<sub>3</sub> (Awasthi, unknown date).

## Chapter Fourteen: Ammonia Synthesis Process

In this chapter:	
Implement indirect cooling	Use low pressure drop synthesis reactor in combination with smaller particle size catalysts
Use low pressure ammonia synthesis catalysts	Recover waste heat from synthesis gas compressor
Install a purge gas recovery unit (hydrogen recovery unit)	Synthesis gas molecular sieve dryer and direct synthesis converter feed
Improve the ammonia synthesis configuration	

### Best Practices for Energy-Efficient Ammonia Synthesis

- **Implement indirect cooling.** Use indirect cooling to recover heat out of each catalyst bed and reuse it to produce high pressure steam, preheat the boiler feed water and heat the incoming syngas.
- **Use low pressure drop synthesis reactor in combination with smaller particle size catalysts.** Save energy by using small particle size catalysts along with improved reactor designs that compensate for the pressure drop.
- **Use low pressure ammonia synthesis catalysts.** Replace the conventional iron-based catalysts with ruthenium-containing and cobalt-enhanced catalysts and improve the efficiency.
- **Recover waste heat recovery from synthesis gas compressor.** To effectively use the heat recovered from the synthesis gas compressor with the use of a heat exchanger and save energy, inject the boiler feed water into the process gas.
- **Install a purge gas recovery unit (hydrogen recovery unit).** Install a purge gas recovery unit to recover hydrogen and reuse it in the synthesis loop to save energy or increase production.
- **Synthesis gas molecular sieve dryer and direct synthesis converter feed.** Use sieve adsorbers to free purge gas of water and carbon dioxides and direct feed the purge gas to the synthesis reactor to improve ammonia conversion and save energy.
- **Improve the ammonia synthesis configuration.** Alter the ammonia synthesis configuration to allow heat recovery at high temperatures for high pressure steam production and improve energy efficiency.

#### Implement indirect cooling.

Ammonia synthesis reactors differ in the way the reaction heat is recovered and in the temperature controlling of the reactants. There are two methods used; quenching or indirect cooling. In *quenching* (direct cooling), a part of the recycle gas enters the first catalyst bed at about 750°F (400°C) and exits at 930°F (500°C). The gas temperature is lowered (quenched) before entering the next catalyst bed by a cooler (300-390°F (150-200°C)) recycle gas (cold shot) (UNIDO, 1979). The introduction of the cooling gas lowers the ammonia concentration and decreases the temperature at the exit of the reactor. In *indirect*

*cooling*, heat exchangers are used to cool the gas and recover heat out of each catalyst bed. The recovered heat can be used to produce high pressure steam, preheat the boiler feed water and even heat the incoming syngas to the desired inlet temperature. Reactors employing the indirect cooling method reduce energy use by 0.6 MMBtu/ton NH<sub>3</sub> compared to quenching reactors. The payback period was 1.5 years for Japanese plants, but will be substantially higher in U.S. conditions. Other potential benefits from adopting the indirect cooling method are a higher conversion rate per pass and lower catalyst volumes (IPTS/EC, 2007).

### Low pressure drop synthesis reactor in combination with smaller particle size catalysts.

The catalyst activity can be improved by increasing the surface area per unit volume of the catalyst modules. Increased catalyst activity results in reduced recirculation rate and/or lower synthesis pressure. A decreased recirculation rate will lower the power requirements of the circulator and the refrigerator. The increased concentration of ammonia in the exit gases increases the condensation temperature, decreasing the power requirements for refrigeration (Japan Chemical Industry Association, unknown date).

Although the use of smaller particle size catalysts increases the reaction rate if the gas velocity in the catalyst bed is not decreased, it can result in increased pressure drop that will limit energy savings. The pressure drop can be reduced with the use of radial flow, cross sectional flow, and axial-radial flow converters that operate at relatively low gas velocities and permit the use of small size catalysts. The electricity savings due to the use of smaller particle size catalysts and improved designs of ammonia synthesis reactors range between 4.5 and 9 kWh/ton NH<sub>3</sub>. The overall energy savings are estimated at 0.7 MMBtu/ton NH<sub>3</sub> (Japan Chemical Industry Association, unknown date).

**CASE STUDY:** The Indian IFFCO Kalol plant replaced the axial synthesis reactor with an axial-radial converter. This allowed the increase of the catalyst volume from 65 m<sup>3</sup> to 75 m<sup>3</sup> and the use of smaller particle size catalyst. The increased ammonia conversion rate per pass decreased the power requirements. Energy use was reduced by 1.0 MMBtu/ton NH<sub>3</sub> (Nand and Goswami, 2009).

### Use low pressure ammonia synthesis catalysts.

Ruthenium-containing and cobalt-enhanced catalysts are characterized by higher activity per volume compared to the conventional iron-based catalysts which are used for ammonia synthesis. Main benefits are lower catalyst volumes, lower operating pressure, and a higher conversion rate per pass. Energy savings are about 0.8-1.2 MMBtu/ton NH<sub>3</sub> (UNIDO, 1979; IPTS/EC, 2007) however, they could be (partly) offset by increased energy requirements for ammonia refrigeration (IPTS/EC, 2007). At high pressures most of the ammonia can be condensed by cooling water while at lower pressures (15-20 MPa), the refrigeration requirements are high. Examples of different catalyst types are:

- Cobalt-modified magnetite catalyst. The activity per volume is twice that of conventional iron-based catalysts. The use of cobalt was introduced in 1984 by ICI. It was initially used in an ammonia plant in Canada using the ICI Catalco's AMV process.
- Iron-based catalyst using wustite instead of magnetite. This type of catalyst is used in at least seven ammonia plants (total capacity 5,600 tons/day).

- Ruthenium on a graphite support catalyst. The ruthenium catalyst used in the Kellogg Advanced Ammonia Process (KAAP) has a considerably higher surface area than conventional iron-based catalysts, and is claimed to be 10-20 times more reactive than iron-based catalysts. Three plants in Trinidad use the KAAP ruthenium-based catalyst. Tøpsøe has also developed a ruthenium-based catalyst.

### **Recover waste heat from synthesis gas compressor.**

The heat recovered from the synthesis gas compressor with the use of a heat exchanger is frequently discarded. There is a potential to recover this heat to preheat the methanator feed gas, however, this has been shown to hinder temperature control of the LTS converter and shorten the catalyst life. To effectively use the heat exchanger, the boiler feed water can be injected into the process gas allowing for better temperature control. Typical temperatures in the LTS converter, using a copper oxide/zinc oxide catalyst are about 390-430°F (200-220°C) (IPTS/EC, 2007). When the heat is exchanged with the compressor exit gas, the inlet temperature of the LTS converter increases from 417°F (214°C) to 460°F (238°C). By injecting the boiler feed water at 130°C into the process gas, the sensible heat is changed into latent heat. In this way, the heating value increases without raising the temperature, which is maintained at the set level of 417°F (214°C). The use of boiler feed water increases the supply rate of latent heat to the process re-boiler of the CO<sub>2</sub> regenerator. As a result, the load of feed steam to the steam re-boiler can be decreased (Japan Chemical Industry Association, unknown date). This maximizes heat recovery of the synthesis gas compressor heat exchanger, reducing the amount of heat rejected in cooling water. The payback period was about 2 years, but is likely to be higher under U.S. conditions. The energy savings are estimated at 0.1-0.2 MMBtu/ton NH<sub>3</sub> (A2A Toolkit).

### **Install a purge gas recovery unit (hydrogen recovery unit).**

The conversion per pass is only 20-30%, resulting in high volumes of recycled gas. The synthesis gas contains small quantities of methane and argon (inerts), which build up in the loop. To achieve an optimum conversion it is necessary to purge a certain quantity of gas from the synthesis loop to reduce the concentration of these inerts. This purge gas is sometimes used as fuel in the primary reformer, after recovery of ammonia in the purge gas absorber. This purge gas contains also hydrogen that can be recovered by installing a purge gas recovery unit (hydrogen recovery unit). The recovered hydrogen is sent back to the synthesis loop to increase production or save energy, as the quantity of hydrogen produced by steam reforming can be reduced (Nand and Goswami, 2009).

Membrane, cryogenics, and pressure swing adsorption (PSA) processes have all been commercially applied for the recovery of hydrogen from the purge gas. The choice of separation technology is driven by the desired purity, degree of recovery, pressure, and temperature. Membrane separators are widely accepted to recover hydrogen from purge gas and recover typically 85-90% hydrogen, with a hydrogen purity of 87-90%. The cryogenic process operates at high pressures (7 MPa) and can achieve a hydrogen recovery of 90-98%. Pretreatment of the purge gas to remove ammonia and water is required for the cryogenic process. Pressure swing adsorption has been used for ultra-high-purity hydrogen from the purge gas and has a somewhat lower hydrogen recovery (70-85%) than the membrane and cryogenic processes. No pretreatment is required and water and ammonia are removed by PSA in addition to argon and methane.

When comparing membrane separators with cryogenic technology, it is noted that recovery based on cryogenic technology is more energy-efficient, whereas the recovery based on membrane technology requires a lower investment. The choice of technology will depend on the plant characteristics (Christensen, 2001a). Most modern reformer-based ammonia plants installed purge gas recovery units, saving on average between 0.6 and 1.0 MMBtu/ton ammonia (Nand and Goswami, 2009).

### **Synthesis gas molecular sieve dryer and direct synthesis converter feed.**

The make-up synthesis gas contains water and CO<sub>2</sub> that are poisonous to the ammonia synthesis catalyst and need to be completely removed. As water and CO<sub>2</sub> can be fully absorbed by ammonia condensation, in older plants, the make-up synthesis gas is usually fed at the exit stream gas of the synthesis reactor. In this plant configuration, the condensation unit is placed between the compressor and the synthesis reactor. The main drawbacks are the decreased ammonia concentration (due to the dilution with make-up gas) and the higher amount of ammonia entering the synthesis reactor (at equal condensing temperatures there is higher ammonia concentration at the entrance of the converter). An additional drawback is that all produced ammonia must be compressed along with the make-up gas in the recycle compressor, a configuration that results in increased power needs for compression.

With the use of molecular sieve adsorbers serving as dryers, the make-up gas stream can be completely freed of water and carbon oxides prior to its entrance in the ammonia synthesis reactor. The make-up gas can then be directly fed to the synthesis reactor, and saves the most energy (Ullmann's, 2011). The conversion rate is improved due to the lower ammonia content in the gas entering the reactor. The improved conversion will reduce the energy requirements for recycling non-activated gas and potentially reduce the loop operating pressure and thus, reduce the power requirements for compression. The energy savings are estimated at 0.3-0.6 MMBtu/ton NH<sub>3</sub> (A2A Toolkit). The molecular sieve drying of make-up gas due to its higher energy efficiency performance, has found wide implementation, also as a revamp in existing ammonia plants (Ullmann's, 2011).

### **Improve the ammonia synthesis configuration.**

The reaction heat of ammonia synthesis is about 2.6 MMBtu/ton of NH<sub>3</sub>. The utilization of this heat at the highest possible temperature to produce high pressure (HP) steam can significantly improve the overall energy efficiency of the plant. There is a trend in new ammonia plants to increase the conversion per pass which results in higher ammonia concentrations at the converter outlet and lower outlet temperatures from the last conversion bed. To produce HP steam, a part of the heat needs to be recovered before the reaction is completed in the synthesis converter system. This can be accomplished with the use of three catalyst beds in separate pressure vessels and the use of waste heat boilers after the second and the third vessel and an inlet-outlet heat exchanger for the first catalyst bed. Several ammonia plants have installed an additional ammonia synthesis converter in combination with an HP steam waste heat boiler, downstream of the existing ammonia converter. The result is increased conversion per pass, reduced compression requirements due to the smaller recycle gas stream, and improved waste heat recovery (CDM, 2004).

Various manufacturers provide systems to recover the high-pressure steam (e.g. Haldor Topsoe and KBR). Steam production can be achieved by removing the existing internal heat exchanger bundle at the top of the converter and incorporating a new, specially engineered external heat exchanger. The energy savings are estimated at 0.8-1.2 MMBtu/ton NH<sub>3</sub> and will depend on the existing configuration (KBR, 2009).

## Chapter Fifteen: Measures Specific to Urea Production

In this chapter:	
Adopt stripping	Use isobaric double recycling (IDR)
NH <sub>3</sub> washing from inerts	Redirect fines to the concentrated urea solution
Employ heat integration in stripping plants	Adopt new carbamate condenser design
Use high efficiency reactor trays	

### Best Practices for Energy-Efficient Urea Production

- **Adopt stripping.** Reduce the energy use by adopting the stripping method as the conversion efficiency is better than in the conventional method, heat can be recovered at high temperatures, and the energy use for decomposition and recompression is eliminated.
- **Use isobaric double recycling (IDR).** For the removal of unreacted ammonia and ammonium carbamate, use the IDR process (or parts of it as revamp) and decrease the energy consumption.
- **NH<sub>3</sub> washing from inerts.** In NH<sub>3</sub> washing from inerts, energy can be recovered from the washed inerts and the added flammable gases.
- **Redirect fines to the concentrated urea solution.** Redirect the concentrated dust generated by the granulator to the concentrated urea solution and save energy.
- **Employ heat integration in stripping plants.** Energy efficiency can substantially increase if heat integration systems between several sections of the plant are implemented.
- **Adopt new carbamate condenser design.** Adopt a new carbamate condenser design for improved heat transfer and save energy.
- **Use high efficiency reactor trays.** Use improved reactor tray designs to improve mixing and increase the conversion efficiency.

#### Adopt stripping.

In all urea plants that use the stripping method, the produced urea solution is further heated at a pressure similar to that of the reactor. “Stripping” results in the decomposition of carbamate in ammonia and (liquid) CO<sub>2</sub>. Due to the elevated temperatures, part of the ammonia and CO<sub>2</sub> is converted from a liquid to a gaseous phase. In this way, ammonia and CO<sub>2</sub> are separated from the liquid urea. After their separation, the CO<sub>2</sub> and ammonia gases are cooled, and part of the gases is recycled after liquefaction of the CO<sub>2</sub> and ammonia to form ammonium carbamate (“carbamate condensation”). The formed ammonium carbamate is then recycled to the reactor (Meessen, 2010).

The main advantage of the stripping method is that no water is added to the recycle. This avoids the negative effects of high water concentration on the conversion efficiency. In addition, as condensation and carbamate formation take place under high temperatures and pressures, the heat of condensation and the heat released from the exothermic reaction of carbamate formation can be recovered at high

temperatures (Meessen, 2010). Stripping is less energy intensive as the energy used in conventional processes for the decomposition at low pressures and in recompression for recycling is avoided (IPTS/EC, 2007). There are various stripping processes in use that differ on:

- The type of the stripping agent (e.g. CO<sub>2</sub>, NH<sub>3</sub>),
- The amount of ammonium carbamate or ammonia recycled back to the reaction zone via the high-pressure loop or via lower-pressure loops,
- The temperature, pressure and composition during reaction,
- The driving forces in the recycling loop (e.g. gravity),
- Materials used.

Adopting stripping in existing conventional urea plants can be justified only when planning to increase plant capacity. In one urea plant, the energy savings from the adoption of CO<sub>2</sub> stripping equaled 1.5-1.6 MMBtu/ton urea (IPTS/EC, 2007).

### **Use isobaric double recycling.**

In the isobaric double recycling (IDR) stripping process, the unreacted ammonia and ammonium carbamate are decomposed/stripped in two decomposers/strippers arranged in series. Stripping is performed at synthesis pressure. The NH<sub>3</sub> to CO<sub>2</sub> ratio is high (4-5) resulting in a gas high in unreacted ammonia. In the first steam-heated stripper, unreacted NH<sub>3</sub> is removed from the urea solution. In the second stripper, where steam heating and CO<sub>2</sub> stripping are applied, the remaining NH<sub>3</sub> and some ammonium carbamate are removed (Meessen, 2010). The urea solution leaving the two high pressure strippers contains un-converted NH<sub>3</sub>, CO<sub>2</sub> and ammonium carbamate (EFMA, 2000c). These residuals are removed in two successive medium-pressure strippers which are heated with low pressure recovered steam. The overall energy use in IDR urea plants is lower than in conventional plants (IPTS/EC, 2007). However, the IDR process, most probably due to its complexity, has not been widely used. The IDR process or parts of the process are used as revamps in conventional plants (Meessen, 2010).

### **NH<sub>3</sub> washing from inerts.**

To remove the NH<sub>3</sub> contained in the inert purge gas released from the urea synthesis section, the inerts can be washed with water after the addition of a flammable gas such as natural gas. The amount of the flammable gas should be such that the composition is kept at safe levels. The washed inerts along with the flammable gas can be sent to the burners, recovering the energy from the inert gas (IPTS/EC, 2007).

### **Redirect fines to the concentrated urea solution.**

The oversized and undersized products formed in the urea granulation unit are recycled back to the granulator where they form the nuclei of the granules. The dust generated during the granulation process is recycled back to the granulator where it is taken along with the fluidization air to the scrubber and ends up in a dilute solution. Because the dust solution is already concentrated due to evaporation, instead of redirecting it to the granulator, it could be directed to the concentrated urea solution. A urea plant that adopted this dust recycling configuration saved about 35,000 tons of steam on an annual basis (IPTS/EC, 2007).



### Employ heat integration in stripping plants.

Improving the heat integration between the synthesis section and downstream sections in urea plants can substantially reduce the energy requirements. For example, the condensation heat in stripping plants can be recovered as low-pressure (LP) steam, or heat exchange can take place between the LP and medium pressure decomposition stages and the evaporation stages. Depending on the degree of integration, the urea plant exports LP steam (IPTS/EC, 2007). Improved heat integration systems have been developed to considerably increase the overall energy efficiency (Sakata and Yanagawa, 2001; Stamicarbon, 2014).

### Adopt new carbamate condenser design.

Conventional high pressure carbamate condensers (HPCC) have certain disadvantages (Orphanides, 2004):

- Uneven distribution of the gas/liquid load in each tube that results in reduced condensation efficiency and hot spots that increase the corrosion rate,
- Short retention time that results in reduced condensation efficiency, and
- Reduced heat transfer, in the case of the falling film condensers.

In the past two decades, several advancements have led to improved carbamate condenser designs. The *pool condenser* is an advanced condenser design in which the gases subject to condensation are present in bubbles while the continuous phase is the liquid phase. The use of this type of condensation has several advantages. Turbulence is created from the rising of the bubbles through the liquid resulting in improved heat transfer. In addition, the water and  $\text{NH}_3$  formed from the dehydration of ammonium carbamate have a higher boiling point than ammonia and ammonium carbamate, resulting in improved heat transfer (IPTS/EC, 2007; Meessen, 2010).

### Use high efficiency reactor trays.

To reach high conversion efficiency in the synthesis reactor, good transfer of heat and mass is important. In an improved reactor tray design, separate and distributed paths are created that result in better mixing between the gaseous and liquid phases. The trays are made up by inverted U beams with special large perforations for liquid passage. With this reactor design, very small bubbles are generated, resulting in high specific surface for the mass and heat transfer (Zardi, 2010). Improved mixing results in improved conversion efficiency (Meessen, 2010). Currently, more than 50 plants use high efficiency reactor trays.



## Chapter Sixteen: Measures Specific to Ammonium Nitrate Production

### In this chapter:

Optimize the neutralization step	Recover residual heat for cooling
Optimize energy use and steam export	Recycle nitrogen compounds

### Best Practices for Energy-Efficient Ammonium Nitrate Production

- **Optimize the neutralization step.** Improve the overall energy efficiency by optimizing preheating, adopting two neutralizer stages and, based on the steam availability, consider operating at high pressures.
- **Recover residual heat for cooling.** The heat contained in the large volumes of low temperature steam that is released during production can be recovered and reused somewhere else in the process.
- **Optimize energy use and steam export.** Optimize the way the generated heat is utilized across the plant and limit the energy use.
- **Recycle nitrogen compounds.** Recover and reuse the nitrogen compounds found in the contaminated process steam.

#### Optimize the neutralization step.

Operating under optimized conditions will result in a more efficient production process. This paragraph gives an overview of the parameters that will affect the performance of Ammonium Nitrate (AN) manufacture (IPTS/EC, 2007).

##### *HNO<sub>3</sub> preheating*

The neutralization of HNO<sub>3</sub> with NH<sub>3</sub> is a strongly exothermic process. An effective way of utilizing the generated heat is to preheat the HNO<sub>3</sub>. The amount of heat needed for preheating is determined by the enthalpy energy balance from the HNO<sub>3</sub> and the NH<sub>3</sub> concentrations.

##### *Neutralizer stages*

There are single-stage and two-stage neutralizers used in the industry. Two-stage neutralizers operate with a high pH in the first stage and a low pH in the second stage. Due to the pH difference, the NH<sub>3</sub> emissions are lower, saving feedstock. The adoption of two-stage neutralizers is possible in existing plants; however, the required investment is high.

##### *Pressure*

Operating the neutralization step under high pressures results in increased generation of steam and higher AN concentrations. Although some energy is required to pressurize the neutralizer, plants operating under high pressures are net producers of energy (excluding product finishing) while older plants, operating at atmospheric pressure are steam importers. Because atmospheric neutralizers are less

expensive and simpler to operate, they are chosen most often when there are sufficient steam volumes available.

The energy balances of different neutralization processes by Uhde show that plants with vacuum neutralization are energy importers (+173 kJ/kg AN), plants with pressure neutralization and with steam production are energy exporters (-515 kJ/kg AN), and plants with pressure neutralization and direct heat recovery are almost self-sufficient (+17 kJ/kg AN). The latter can also be energy exporters (1,095 kJ/kg AN) if all low and vacuum pressure vapors are utilized (Erben, 2009).

Other parameters that play an important role on the overall process efficiency are the impurity level, and the operating temperature level. Impurities such as carbon, chloride, and heavy metals, should be avoided as these catalyze the decomposition of AN. High operating temperatures lead to the decomposition of AN. Nowadays, an operating temperature of 356°F (180°C) is considered the maximum acceptable (Erben, 2009).

### **Recover residual heat for cooling.**

During AN production, large volumes of contaminated low temperature steam (257-266°F (125-130°C)) are released into the atmosphere. This low temperature heat could be recovered and re-used somewhere else in the process e.g., for product cooling or chilling water (IPTS/EC, 2007). A LiBr/H<sub>2</sub>O absorption cooler has been installed at an ammonium nitrate plant in Spain, Fertiberia, S.A., to utilize the low-temperature heat for product cooling at the granulation plant (Galindo and Córton, 1998).

### **Optimize energy use and steam export.**

The AN production process is highly exothermic, and the generated heat is typically used to preheat HNO<sub>3</sub> or concentrate the AN solution. The amount of heat recovered to preheat the HNO<sub>3</sub> depends on the HNO<sub>3</sub> concentration, as it affects the amount of water that needs to be removed. The typical energy use in AN plants is in the range of 0.4-0.6 MMBtu/ton AN (0.5-0.7 GJ/tonne). However, modern AN plants have an energy use of 0.08-0.19 MMBtu/ton AN (0.09-0.22 GJ/tonne) (IPTS/EC, 2007).

Heat is also needed to evaporate the AN solution. The amount of heat needed depends on the AN concentration and the required product concentration. For this purpose, steam from the neutralizer could be used. However, this might not be an option for retrofitting existing plants.

For plants that only make AN solution, up to 340 lb. steam/ton (170 kg steam/tonne) of AN can be exported. The production of AN solution with 95% AN is possible with no additional energy use for evaporation (IPTS/EC, 2007).

### **Recycle N compounds.**

A part of the process water that is fed along with HNO<sub>3</sub> is removed from the process as process steam or from the evaporation section. The process steam can be contaminated with AN, HNO<sub>3</sub> or NH<sub>3</sub>. Per the EFMA (2000d), contaminated condensate can be re-used or purified by 1) stripping with air or steam with the addition of alkali to liberate ionized ammonia if required, 2) distillation, or 3) membrane separation techniques, such as reverse osmosis.

## Chapter Seventeen: N<sub>2</sub>O Abatement Measures for Nitric Acid Production

In this chapter:	
<i>Primary N<sub>2</sub>O controls</i>	
Oxidation catalyst and campaign length	Optimize ammonia oxidation
Use improved and alternative oxidation catalysts	
<i>Secondary N<sub>2</sub>O controls</i>	
Homogeneous N <sub>2</sub> O decomposition by extension of the reactor chamber	Catalytic N <sub>2</sub> O decomposition in the reaction chamber
<i>Tertiary N<sub>2</sub>O controls</i>	
Thermal N <sub>2</sub> O decomposition	Catalytic N <sub>2</sub> O decomposition in tail gases
Non-selective catalytic reduction of NO <sub>x</sub> and N <sub>2</sub> O in tail gases	Combined N <sub>2</sub> O and NO <sub>x</sub> abatement with hydrocarbons

Nitrous oxide (N<sub>2</sub>O) emissions are formed during ammonia oxidation and are a by-product of the nitric acid production process. N<sub>2</sub>O is a powerful greenhouse gas. The amount of N<sub>2</sub>O that is generated depends on the a) oxidizing unit, b) catalyst composition, c) catalyst age, and d) burner design (U.S. EPA, 2010).

The N<sub>2</sub>O control methods can be categorized based on their location within the nitric acid production process (Pérez-Ramírez et al., 2003). See also Figure 5.

- a) *Primary*. Reducing the amount of N<sub>2</sub>O generated during ammonia oxidation. This is possible by changing the catalyst and/or by modifying the operating conditions.
- b) *Secondary*. Reducing N<sub>2</sub>O emissions immediately after generation. Right after N<sub>2</sub>O is formed, it is decomposed to N<sub>2</sub> and O<sub>2</sub> with the help of a catalyst. N<sub>2</sub>O emissions can be reduced by 90% while the associated cost is kept to a minimum, as there are no modifications taking place in the ammonia oxidation catalyst. This technology is used in more than 60 nitric acid plants worldwide (Durilla, 2009).
- c) *Tertiary*. Reducing N<sub>2</sub>O emissions either by catalytic decomposition or by catalytic reduction upstream or downstream of the tail gas expansion unit.

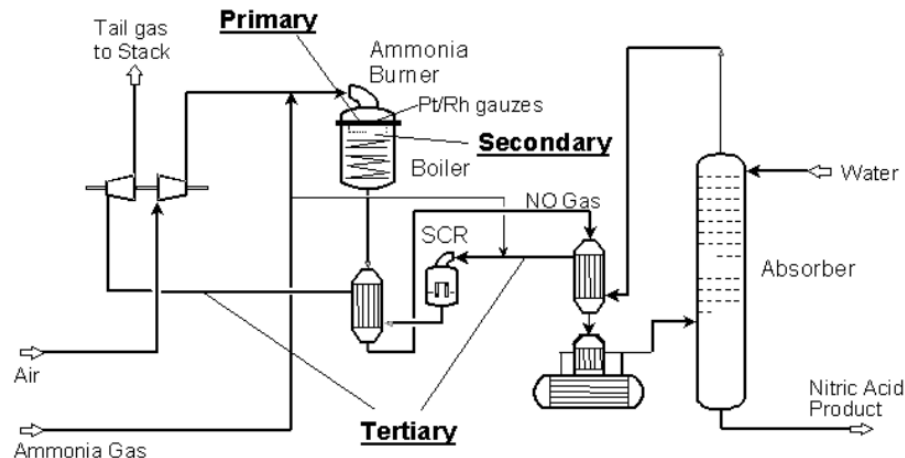

Figure 5: Classification of nitrous oxide abatement measures based on the process location (Groves et al., 2006a).

The secondary and tertiary N<sub>2</sub>O emission control methods are the methods most commonly used in nitric acid plants (Durilla, 2009). Non-selective catalytic reduction (NSCR) is a tertiary technology commonly used in U.S. nitric acid plants to limit NO<sub>x</sub> emissions (U.S. EPA, 2010). NSCR, however, also achieves important N<sub>2</sub>O emission reductions of up to 95%.

## Best Practices for N<sub>2</sub>O Control

### Primary N<sub>2</sub>O controls

- **Oxidation catalyst and campaign length.** Despite the existing platinum recovery systems, to maintain an optimized operation the catalyst needs to be replaced 1-4 times a year.
- **Optimize ammonia oxidation.** Optimize important parameters such as the ammonia/air ratio and the operating temperatures and pressures.
- **Improved and alternative oxidation catalysts.** Use improved catalyst designs and compositions to enhance the conversion efficiency and limit by-product formation.

### Secondary N<sub>2</sub>O controls

- **Homogenous N<sub>2</sub>O decomposition by extension of the reactor chamber (thermal decomposition).** In new plants, an extending reactor chamber can be employed to thermally decompose N<sub>2</sub>O by 70-85%.
- **Catalytic N<sub>2</sub>O decomposition in the reaction chamber (high temperature catalytic decomposition).** N<sub>2</sub>O can decrease by 80-90% by adding a secondary catalyst after the Pt-Rh catalyst in the reaction chamber that promotes N<sub>2</sub>O decomposition.

### *Tertiary N<sub>2</sub>O controls*

- **Thermal N<sub>2</sub>O decomposition.** N<sub>2</sub>O can be thermally decomposed by raising the temperature of the tail gas.
- **Catalytic N<sub>2</sub>O decomposition in tail gas.** By passing the tail gas through special catalysts, the N<sub>2</sub>O that is present can be reduced by up to 99%.
- **Non-selective catalytic reduction of NO<sub>x</sub> and N<sub>2</sub>O in tail gas.** Reduce N<sub>2</sub>O emissions by 95% and NO<sub>x</sub> emissions by 90% with an NSCR system.
- **Combined N<sub>2</sub>O and NO<sub>x</sub> abatement with hydrocarbons.** For plants with a low tail gas temperature, N<sub>2</sub>O emissions can be decreased with the use of hydrocarbons and iron zeolite catalysts.

### *Primary N<sub>2</sub>O controls*

All measures that increase ammonia conversion efficiency will decrease N<sub>2</sub>O formation; for every mole of NH<sub>3</sub> converted into NO one less mole of N<sub>2</sub>O will be produced (Pérez-Ramírez et al., 2003). This results in feedstock savings, and from that perspective this method should be preferred over installing N<sub>2</sub>O controls.

### **Oxidation catalyst and campaign length.**

The oxidation catalyst commonly used is composed of platinum (Pt) with 5-10% rhodium (Rh) and up to 5% palladium (Pd). During ammonia oxidation some of the platinum vaporizes. It is common for nitric acid plants to install a platinum recovery system right after the catalyst. Platinum vaporization decreases the mechanical strength of the catalyst and increases the rhodium content which results in a lower NH<sub>3</sub> conversion efficiency and higher by-product formation (i.e. N<sub>2</sub>O and N<sub>2</sub>) (Pérez-Ramírez et al., 2003). Despite the existing platinum recovery systems, to guarantee an optimized operation the catalyst needs to be replaced 1-4 times a year.

### **Optimize ammonia oxidation.**

In a nitric acid plant, the ammonia-to-air ratio, and the operating temperatures and pressures affect the production rates and product quality and should therefore be set as close to the optimum while taking into consideration the technical plant limitations. While in new plants optimizing these parameters is relatively easy, in existing plants the adaptation might be harder (IPTS/EC, 2007). By optimizing the ammonia oxidation step, the NO yield can be optimized and the generation of undesired co-products such as N<sub>2</sub>O can be limited. An optimum NO yield can be achieved at an ammonia-to-air ratio of 9.5-10.5% ammonia (volume based). In addition, the NO yield can increase at low pressures and at optimum temperatures of 1380-1650°F (750-900°C) (IPTS/EC, 2007). Although operating at high temperatures (above 1,650°F (900°C)) and with a relatively new gauze-pack, the N<sub>2</sub>O emissions are reduced, the platinum vaporization increases substantially, resulting in decreased NO yield and high by-product formation (Pérez-Ramírez et al., 2003).

### Use improved and alternative oxidation catalysts.

*Improve conventional Pt-Rh catalysts.* The ammonia conversion efficiency, and decreasing by-product generation, could be increased by improving the geometry and composition of the platinum catalyst. Improved gauze-pack designs can show better heat and mass transfer and better hydrodynamic flow and gas mixture distribution (Pérez-Ramirez et al., 2003). During the past two decades, woven gauzes have been gradually replaced with knitted gauzes (currently 95% of production). There are many variations of knitted gauzes with even multi-layer gauzes being developed that are claimed to be even more efficient (Umicore, 2011). It has been reported that improved gauze designs could decrease N<sub>2</sub>O emissions by 30-50% (IPTS/EC, 2007; InfoMil, 2001; Heraeus, 2006). In addition, the campaign length of the catalyst would also increase.

*Cobalt oxide-based combustion catalysts.* Cobalt oxide (Co<sub>3</sub>O<sub>4</sub>) catalysts have been used in several nitric acid plants to replace the most commonly used platinum-based catalysts. It has been reported that with this catalyst type the NH<sub>3</sub> to N<sub>2</sub>O conversion rate can be as low as 0.5% (Petryk and Kolakowska, 2000). They also last longer and are 75% less expensive (CDC, 2003; Joy Industries, 1998). The benefits of lower N<sub>2</sub>O emissions however, could be offset by the lower NO yields. While some sources claim high NH<sub>3</sub> conversion efficiencies of 93-96% (Sadykov, et al., 2000; Joy Industries, 1998), other sources claim the opposite (88-92% in high-pressure plants) (InfoMil, 2001). In general, the NH<sub>3</sub> conversion efficiency in a nitric acid plant using platinum-based catalysts is in the range of 93-97% (IPTS/EC, 2007). According to Pérez-Ramirez et al. (2003), the main drawbacks of cobalt oxide-based catalysts are the lower NO yield, the lower temperature requirements (>100K lower) that could affect the plant's steam balance, and the deactivation of the catalyst (NH<sub>3</sub> reduces Co<sub>3</sub>O<sub>4</sub> to CoO). Plants using cobalt oxide catalysts in ammonia oxidation are the Insitec plant in Australia and a Simplot plant in Canada (IPTS/EC, 2007).

#### Secondary N<sub>2</sub>O controls

### Homogeneous N<sub>2</sub>O decomposition by extension of the reactor chamber (thermal decomposition).

Under high temperatures (above 1,600°F (870°C)), N<sub>2</sub>O is unstable and decomposes into nitrogen and oxygen. By extending the reactor chamber, the residence time of the process-gas in the hot zone downstream of the Pt-Rh catalyst increases and therefore some of the N<sub>2</sub>O is thermally decomposed into N<sub>2</sub> and O. The reduction of N<sub>2</sub>O emissions will depend on the length of the reactor and it can range between 70 and 85% (Wiesenberger, 2001; IPTS/EC, 2007).

This N<sub>2</sub>O reduction method is not suited as a retrofit measure in existing plants due to the high investment required for redesigning the reactor chamber. It is mostly suited for new plants. Capital costs are expected to be 5-6% higher with no additional change in operation costs (Pérez-Ramirez et al., 2003; InfoMil, 2001). In the case of a modern plant, the emissions could be as low as 3.6 lb. N<sub>2</sub>O/ton HNO<sub>3</sub> (1.8 kg N<sub>2</sub>O/tonne).

**CASE STUDY:** This abatement technology has been successfully installed in a 2,200 tons/day nitric acid plant in Norway where N<sub>2</sub>O emissions were reduced by 70% (Yara, 2009). This technology is not suitable for low pressure plants due to the low residence time of the process gas in the reactor chamber (Pérez-Ramirez et al., 2003).

### Catalytic N<sub>2</sub>O decomposition in the reaction chamber (high temperature catalytic decomposition).

N<sub>2</sub>O under high temperatures is unstable and decomposes into nitrogen and oxygen. However, this thermal N<sub>2</sub>O decomposition reaction takes several seconds. To promote the decomposition, a secondary catalyst could be added in the reaction chamber directly after the Pt-Rh catalyst. Since no major modification/re-design of the reaction chamber is required, this abatement method can be applied in existing and new nitric acid plants. This method of catalytic decomposition (high temperature catalytic decomposition) can be a good option for mono-pressure and older dual pressure nitric plants since, the low temperature catalytic decomposition cannot be applicable as the activity of the tail gas decomposition catalyst is low due to the low tail gas temperatures (InfoMil, 2001). It has been demonstrated that the addition of a secondary catalyst can decrease N<sub>2</sub>O emission by 80-90% (Wiesenberger, 2001; IPTS/EC, 2007). Main disadvantages can be 1) some NO<sub>x</sub>-yield losses (less than 0.5%) resulting in more ammonia needed to produce the same throughput; 2) a considerable pressure drop of 15 mbar; and 3) limited catalyst lifetime of about 2 years due to the high temperatures in the reaction chamber (IPTS/EC, 2007).

There are several catalyst types commercially available: a Cu-Zn-Al catalyst available in several shapes and sizes to assist increased conversion efficiencies of up to 90% and low pressure drops (BASF, 2012), a cerium oxide-based catalyst with conversion efficiencies of up to 90% (Yara, 2009), and ceramic pellets coated with a precious metal offering up to 90% N<sub>2</sub>O emission reduction (Heraeus, 2006). The BASF catalyst has been installed in at least three nitric acid plants in Germany and in Belgium where N<sub>2</sub>O emissions decreased by 60-90%. The lifetime of the catalyst exceeded the 2 years (IPTS/EC, 2007). The Yara catalyst has been installed in 44 nitric acid plants with an average N<sub>2</sub>O abatement of 90% and an average catalyst lifetime of more than 4 years (Yara, 2009). The investments are estimated at \$1.3-1.6/ton HNO<sub>3</sub> produced<sup>7</sup>.

#### *Tertiary N<sub>2</sub>O controls*

### Thermal N<sub>2</sub>O decomposition.

The decomposition of N<sub>2</sub>O under high temperatures could also be used as a tertiary N<sub>2</sub>O abatement measure by raising the temperature of the tail gas to 1,470-2,190°F (800-1,200°C) in a regenerative or recuperative heat exchange reactor. Due to the increased thermal efficiency of the heat recovery system, and for N<sub>2</sub>O concentrations of more than 1,500 ppm (by volume), no additional fuel is required to compensate for the heat losses, apart for some fuel needed during start-up. For tail gases with an N<sub>2</sub>O concentration of less than 1,500 ppm supplementary fuel is needed to maintain the temperature (Galle et al., 2001).

Due to the high investment costs of a regenerative and start-up system, and additional fuel use, this measure is less interesting for most nitric acid plants (Pérez-Ramirez et al., 2003). The implementation of such a measure would be more favorable if the tail gas could be mixed with high-temperature gases or gases with high N<sub>2</sub>O concentration from a nearby industry.

---

<sup>7</sup> This was based on the abatement cost of € (2007) 0.98-1.2/tonne HNO<sub>3</sub> reported in IPTS/EC (2007), and on an 1.11 € inflation rate (Statbureau, 2015) and an average exchange rate for 2014 of 1.33 (USD/EUR).



### Catalytic N<sub>2</sub>O decomposition in tail gases.

Catalytic decomposition does not require the use of agents or additives. For the catalytic decomposition of N<sub>2</sub>O into N<sub>2</sub> and O<sub>2</sub> several technologies have been developed (e.g., EnviNO<sub>x</sub><sup>®</sup> and CRI).

*EnviNO<sub>x</sub><sup>®</sup>*. This abatement technology works on the principle that N<sub>2</sub>O decomposition is promoted at high NO<sub>x</sub> levels. It is developed by Uhde. An N<sub>2</sub>O and NO<sub>x</sub> abatement reactor is placed between the tail gas heater and the tail gas turbine. It consists of two iron zeolite catalyst layers; a de-N<sub>2</sub>O catalyst layer and a de-NO<sub>x</sub>/de-N<sub>2</sub>O catalyst layer. In the first catalyst layer, N<sub>2</sub>O is decomposed into N<sub>2</sub> and O at the presence of NO<sub>x</sub>. After the first catalysis step, NH<sub>3</sub> vapor is injected to react with NO<sub>x</sub> and form N<sub>2</sub> and water vapor under the presence of the second catalyst. The reactions are all exothermic. This results in higher tail gas temperatures at the entrance of the tail-gas turbine and therefore increased heat recovery that compensates for the reduced heat recovery due the pressure drop because of the adopted abatement reactor (CDM, 2006). The N<sub>2</sub>O concentration can decrease by 98-99% (N<sub>2</sub>O emission level 0.12-0.25 kg N<sub>2</sub>O). The NO<sub>x</sub> concentration can also decrease by 99% (NO<sub>x</sub> emission level less than 5 ppm) (IPTS/EC, 2007).

This abatement option is applicable in nitric acid plants with high tail gas temperatures (more than 790°F (420°C)) as the N<sub>2</sub>O decomposition decreases dramatically at lower temperatures (Groves et al., 2006b). High tail gas temperatures in the range of 750-930°F (400-500°C) are available in large dual-pressure and in high (mono) pressure plants (Pérez-Ramírez et al., 2003). Plants could increase their tail gas temperature (i.e. from 727°F (387°C) to 815°F (435°C)) by decreasing the surface of the heat exchanger from the process cooler and by installing a bypass system (CDM, 2006). The investment costs are estimated at \$1.3-1.6/ton HNO<sub>3</sub> produced (IPTS/EC, 2007).

*C-NAT*. The CRI N<sub>2</sub>O abatement technology (C-NAT) developed by CRI can decrease N<sub>2</sub>O emissions by 98% (CRI, 2010a). It can be implemented in new nitric plants and as a revamp in existing plants. It can be installed either upstream or downstream from the tail gas expander. The CRI catalyst is contained in thin layers between gas channels of a packed-bed type reactor. The lateral flow of the tail gas through the catalyst layers results in increased conversion efficiency and low pressure drop. It can be implemented for tail gas temperatures of 840-1,220°F (450-660°C) but it could also be implemented at lower temperatures in combination with a waste heat recovery system (CRI, 2010b).

### Non-selective catalytic reduction of NO<sub>x</sub> and N<sub>2</sub>O in tail gases.

The non-selective catalytic reduction (NSCR) technology was initially developed to reduce NO<sub>x</sub> emissions, but it can also considerably reduce N<sub>2</sub>O emissions. To reduce NO<sub>x</sub> and N<sub>2</sub>O, a reducing agent (e.g. natural gas, hydrogen, ammonia purge gas) is added to the tail gas. First, all the free O<sub>2</sub> contained in the tail gases is consumed, and then, all the O<sub>2</sub> contained in the NO<sub>x</sub> and N<sub>2</sub>O gases is consumed. The catalysts are based on platinum, vanadium pentoxide, iron oxide or titanium (IPTS/EC, 2007). The fuel needed to reduce all O<sub>2</sub> present in the tail gas is the stoichiometric amount needed plus an excess of 0.5% (volume-based). As the age of the catalyst increases, more fuel will be needed to reduce all O<sub>2</sub>. Prior to entering the catalyst layer, the tail gas needs to be pre-heated. The temperature that needs to be reached will depend on the reducing agent used; that is 390-570°F (200-300°C) for H<sub>2</sub> and 840-1067°F (450-575°C) for natural gas (IPTS/EC, 2007). The reactions are exothermic and after the catalytic reduction the tail gas temperatures can be higher than 1,470°F (800°C). For this reason, additional cooling is required. When the oxygen



concentration in the tail gas is less than 3% (volume-based) a single stage catalytic reactor is used, while for higher oxygen concentrations a two-stage reactor with an interchange heat removal is required.

N<sub>2</sub>O emissions can be reduced by 95% (below 50 ppm N<sub>2</sub>O) and NO<sub>x</sub> emission by 90% (at 100-150 ppm N<sub>2</sub>O) (Pérez-Ramirez et al., 2003; IPTS/EC, 2007). It should also be considered that the use of fuels will increase the CO<sub>2</sub> emissions. NSCR is used in at least 14 process trains in the U.S. (U.S. EPA, 2010). The NSCR technology is applicable to both new and existing plants. However, the adoption in existing plants will require major modifications. The cost of emission abatement for a new plant will be \$2.4-2.8/ton CO<sub>2</sub>-eq. abated and for existing plants \$2.8-3.7/ton CO<sub>2</sub>-eq. abated (Pérez-Ramirez et al., 2003).

### **Combined N<sub>2</sub>O and NO<sub>x</sub> abatement with hydrocarbons.**

Another version of the EnviNO<sub>x</sub><sup>®</sup> technology described above (see “Catalytic N<sub>2</sub>O decomposition”) was developed for nitric acid plants with a low tail gas temperature (<790°F (420°C)). In this technology, the N<sub>2</sub>O in the tail gas is reduced with the use of hydrocarbons at the presence of iron zeolite catalysts (Groves and Sasonow, 2009). The reduction is more effective when NO<sub>x</sub> is entirely removed from the tail gas. Therefore, NO<sub>x</sub> is removed in the first catalyst bed of the reactor (de-NO<sub>x</sub> catalyst), and then a hydrocarbon is added to react with the N<sub>2</sub>O in the second catalyst bed (de-N<sub>2</sub>O catalyst). It is claimed that NO<sub>x</sub> emissions can decrease to less than 1 ppm while N<sub>2</sub>O emissions are also significantly reduced. The additional GHG emissions from the use of hydrocarbons are less than 0.5% of the N<sub>2</sub>O emission reduction (Groves et al., 2006b).

## Chapter Eighteen: Product Finishing Measures

### In this chapter:

Install plate bank product cooler

Recycle warm air

### Best Practices for Product Finishing

- **Install plate bank product cooler.** Install a plate cooler for product cooling and considerably reduce power consumption.
- **Recycle warm air.** Achieve 6-12% energy savings by recovering the warm air from the cooler exhaust gases and recycling it to the dryer combustion system.

#### Install plate product cooler.

To avoid potential caking in storage, most fertilizers need some additional cooling after drying. The main types of coolers are the rotary drum, fluidized bed, and plate coolers. The most common product cooler used in fertilizer plants is the rotary drum. The rotary drum relies on ambient or chilled air as the cooling medium. The fluid bed coolers also use air as the cooling medium and although they have lower capital costs, the operating costs are higher due to the need for more airflow at a higher pressure drop. Rotary coolers consume about 3 kWh/ton product while fluid bed coolers consume about 5 kWh/ton of product (IPTS/EC, 2007).

The plate cooler has significant capital and operating cost advantages when compared to the rotary drum and fluidized bed cooler technologies. It consists of a vertical bank of hollow plates made of stainless steel. The bulk solids pass slowly between the plates while cooling water is passed counter currently through the hollow plates. The plate bank cooler has the lowest electricity consumption among fertilizer coolers of about 0.5 kWh/ton. This type of cooler requires a much lower capital investment than a drum cooler and is slightly lower than a fluidized bed cooler.

#### Recycle warm air.

Traditionally, the exhaust air from the product cooler (and equipment vents) is sent to a scrubber system. Instead of using a wet recovery system, it is more beneficial to first take the warm air (of about 140-150°F (60 – 65 °C)) and use a fabric filter or high efficiency cyclones to recover the dust and recycle the warm air as dilution air to the dryer combustion system, replacing ambient air. This system has been adopted successfully in dry (Western US) and humid (US Gulf Coast) climates. Potential energy savings range between 6-12%.

## Conclusion: Why Manage Energy?

The U.S. nitrogenous fertilizer industry is a significant energy consumer with an annual energy expenditure of approximately \$334 million. Most of the energy consumed is for the manufacture of ammonia and urea. Typically, ammonia production fuel costs account for about 65% of the overall energy costs. In the U.S., wide adoption of best practice technologies in ammonia manufacturing has the potential to decrease the fuel use for energy purposes by 14%.

Improving energy efficiency is an important way to reduce energy costs and increase predictable earnings. Look strategically at how energy is currently used in plants, systems, and production processes. Focus on the areas where you can generate the greatest savings. This Guide provides many examples of cost-effective best practices to increase energy efficiency including:

- How to create a successful energy management program that assesses and tracks your energy and uses energy teams dedicated to finding and improving your energy savings.
- How to assess and fix energy waste in your plants, systems, and fertilizer production processes as well as at the organizational level.
- How to assess your company in relation to the current state of energy use in nitrogenous fertilizer industry.

The most effective way to reduce energy costs is to cultivate a culture of energy efficiency within your organization. As you learned in Chapter Three, establishing an energy management program creates a culture of energy efficiency while assessing and tracking energy and improving savings. When your entire energy team, plant, and company is engaged in energy management, additional cost saving opportunities can be identified and create a process for continuous energy improvement within the organization.

EPA ENERGY STAR offers tools and resources to help companies develop and continuously improve their energy management programs. These tools and resources include communication materials, assessment tools and guides to help you benchmark your energy performance and energy management practices, and information about how to become an ENERGY STAR partner and participate in competitions to raise awareness about your energy management program. You may access these tools and resources at [www.energystar.gov/industry](http://www.energystar.gov/industry). If your company has questions or needs assistance with building a corporate energy program, please contact [energystrategy@energystar.gov](mailto:energystrategy@energystar.gov).

Despite what efficiency measures you may have implemented in the past, there is always room for additional cost-effective energy efficiency improvements that will pay your company back tenfold and grow your bottom line!

## Acknowledgements

This work was supported by the Climate Protection Partnerships Division, Office of Air and Radiation, U.S. Environmental Protection Agency.

We would like to thank Agrium and Andy O'Hare (The Fertilizer Institute) for their comments and suggestions on the draft report and useful comments. Despite all efforts, any remaining errors are the responsibility of the authors. The views expressed in this Guide do not necessarily reflect those of the U.S. Environmental Protection Agency, or the U.S. government.

## Appendix A: The Ammonia and Nitrogenous Fertilizer Industry

Fertilizers are an essential part of today's agriculture as they supplement important natural nutrients needed for the proper development and growth of plants. Nitrogen (N) is taken up from the soil in the form of nitrate (NO<sub>3</sub>) or ammonium (NH<sub>4</sub>) and is combined with other compounds to form amino acids and proteins. It is an essential protein constituent, involved in all major processes of plant development and yield formation. Sufficient nitrogen supply is also important for the uptake of other nutrients (FAO, 2000).

Due to its great importance in crop production, N is the most consumed primary nutrient. Figure 6 shows that currently nitrogenous fertilizers account for 61% of global fertilizer consumption, having overtaken the use of potassium since the early 1980s.

Nitrogen for crop production derives from decomposing animal and plant waste or from commercially produced fertilizers. The principal source of N in commercial fertilizers is ammonia (NH<sub>3</sub>). Ammonia is produced by the reaction of nitrogen and hydrogen in a catalytic process known as the Haber-Bosch process:

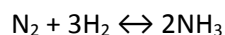

There are two main hydrogen production processes used in ammonia production, which differ in the type of feedstock used; the steam reforming route and the partial oxidation route. The steam reforming route uses natural gas (or other light carbon fuels such as natural gas liquids, liquefied petroleum gas, and naphtha) as feedstock, while the partial oxidation production route uses heavy feedstocks such as residual oils and coal.

Ammonia can be directly applied to the field, or it can be used as an intermediate compound in the production of other nitrogenous fertilizers, with the most important ones being ammonium nitrate (AN), nitric acid (NA), urea, compound fertilizers, and liquid ammonia. The production routes of main fertilizers are depicted in Figure 7. Table 8 shows their composition.

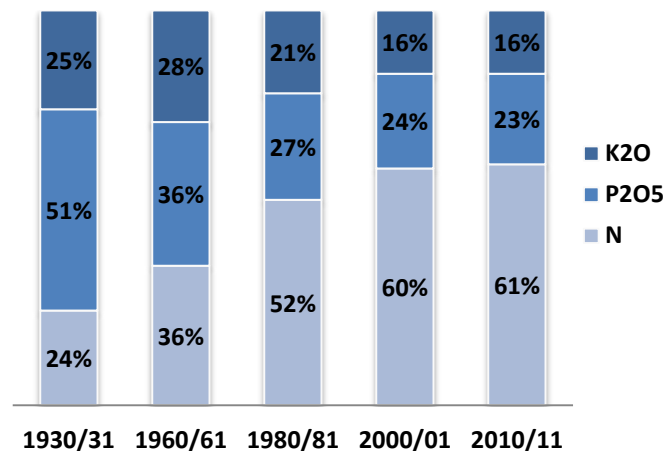

Figure 6: Relative importance of nitrogen, phosphorus, and potassium fertilizers in global fertilizer consumption (IFA, 2013).

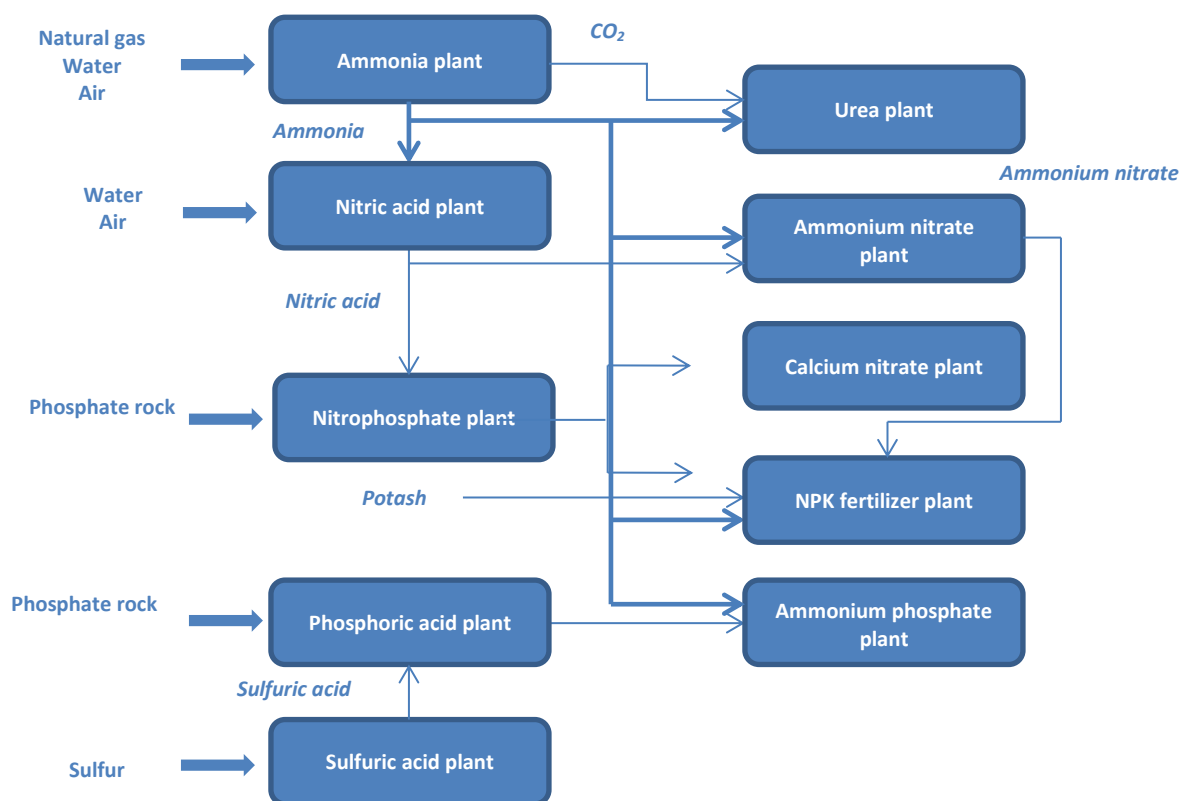

Figure 7: Fertilizer production routes (FAO, 2000).

Table 8. Composition of main nitrogenous and complex fertilizers (nutrients as % of product) (IFA, 2013).

Fertilizers	N	P <sub>2</sub> O <sub>5</sub>	K <sub>2</sub> O	S
Ammonia	82	0	0	0
Ammonium sulphate	21	0	0	23
Ammonium nitrate	33-34.5	0	0	0
Calcium ammonium nitrate	20.4-27	0	0	0
Urea	45-46	0	0	*
NPK fertilizers	5-25	5-25	5-25	*
NP fertilizers	15-25	15-25	0	*
NK fertilizers	13-25	0	15-46	*
PK fertilizers	0	7-30	10-30	*

\* Some with S and/or Mg and/or micronutrients

In 2015, ammonia was produced in 66 countries. In descending order, the largest producers were China (33%), Russia (8%), India (8%), and the United States (6%), cumulatively accounting for 55% of global production. Between 2000 and 2015, global ammonia production increased by about 2%/year, from 119 million tons nitrogen<sup>8</sup> to 161 million tons respectively (USGS, various years). Most of this growth occurred in China. Over the past 15 years, except for China, ammonia production also increased considerably in

<sup>8</sup> In this Energy Guide, and unless mentioned otherwise, all production volumes are in contained nitrogen. To convert one ton of contained nitrogen (nutrient content in ammonia) into one ton of ammonia, divide by 0.822.

Trinidad and Tobago, India, and Russia. In the United States, the production capacity of ammonia significantly decreased over this period by about 35%, to rebound recently due to reduced natural gas prices. Figure 8 shows the historical ammonia production trends since 1996.

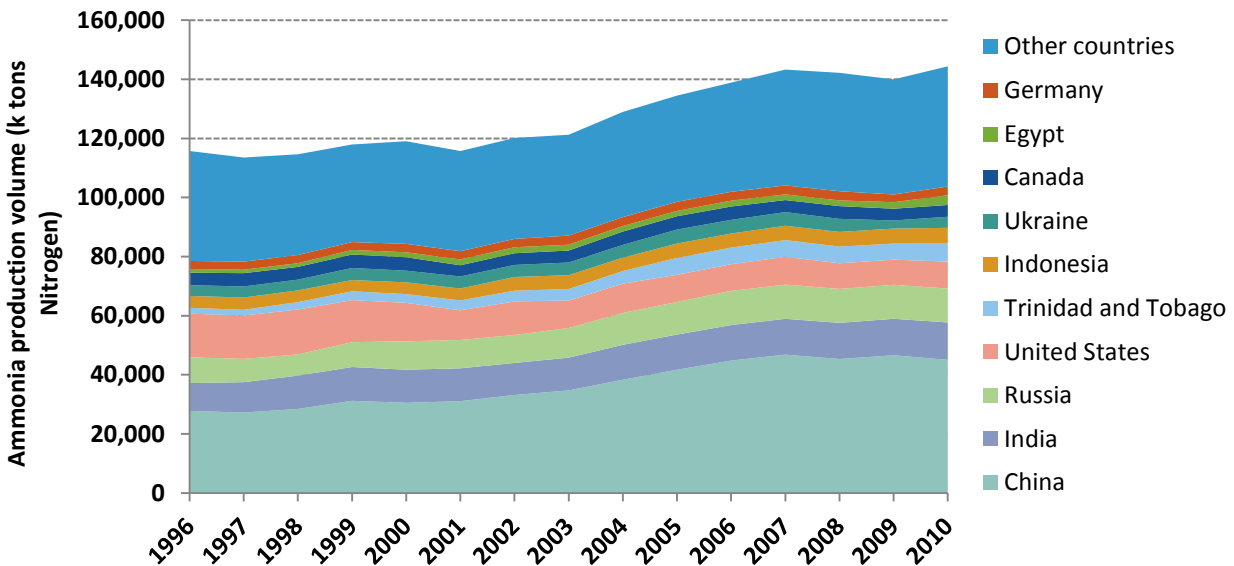

Figure 8: Global historical ammonia production (USGS, various years).

## U.S. Production and Consumption

This appendix gives an overview of the U.S. nitrogenous fertilizer industry and describes the most energy consuming processes, i.e., ammonia and urea production, as well as the production of nitric acid, ammonium nitrate, and ammonium sulfate.

In 2015, the U.S. ammonia industry produced 10.4 million tons N (equivalent to 12.6 million tons ammonia), of which 88% was used in fertilizer production (see Figure 9). The remaining 12% was used in a variety of industrial applications, such as in the manufacture of plastics, fibers, explosives, amines, amides and other organic nitrogen compounds (USGS, 2015a; IPTS/EC, 2007). The most important nitrogenous fertilizers are ammonium nitrate (AN), nitric acid (NA), urea, compound fertilizers, and liquid ammonia.

In the United States, ammonia production has decreased from 11.4 million tons N in 1970 to 10.1 million tons N in 2013, and rebounded to 10.4 million tons N by 2015. During this period, ammonia production fluctuated strongly, peaking at 16.2 million tons (N) in 1980, and again at 15.2 million tons (N) in 1998. In 1972, there were 61 companies in the U.S. operating 91 ammonia plants, with an average plant capacity of about 190,000 tons/year. By 2002, the industry consolidated significantly, with 28 companies operating 37 plants. The average plant size increased to 500,000 tons/year. Ammonia was produced by 13 companies at 29 plants in 15 states in the United States during 2015 (with 2 idled plants).



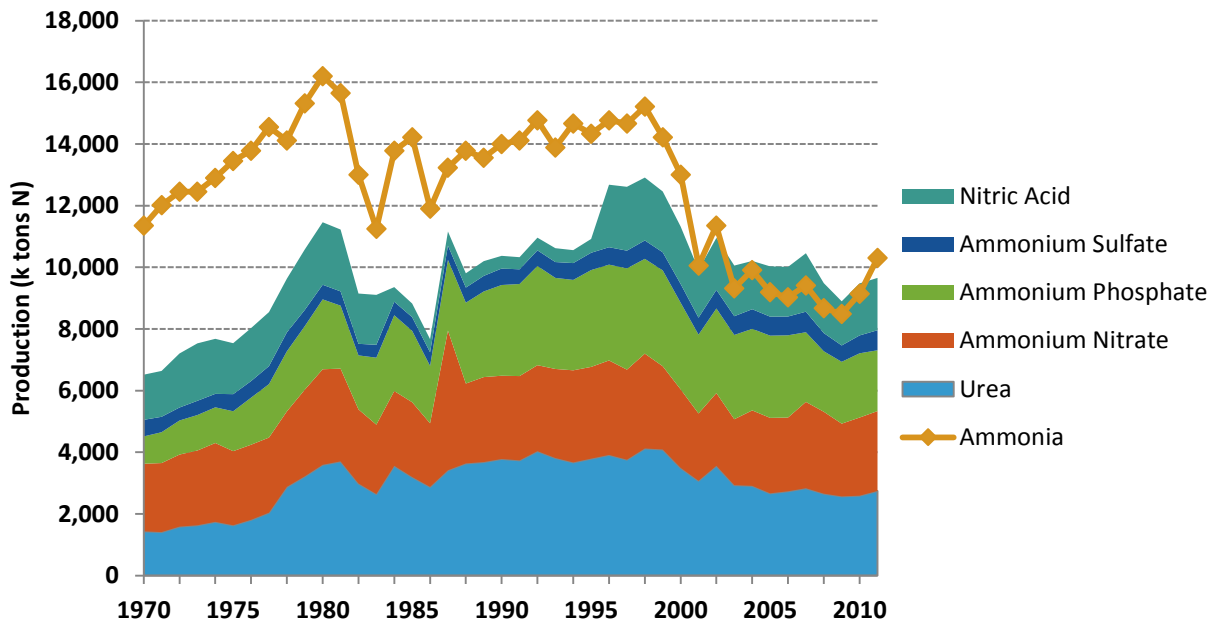

Figure 9: Historical U.S. fertilizer production (USGS, various years).

Appendix F lists the production capacity of ammonia producers in the U.S. in 2013. The largest ammonia capacity is installed in Louisiana (29%), Oklahoma (21%), Texas (6%), Iowa (6%), and Kansas (5%). Due to the large natural gas reserves, three states (Louisiana, Oklahoma, and Texas) account for 56% of installed capacity (USGS, 2015a). **Error! Reference source not found.** depicts the distribution of ammonia production capacity across the U.S. in 2005/2006.

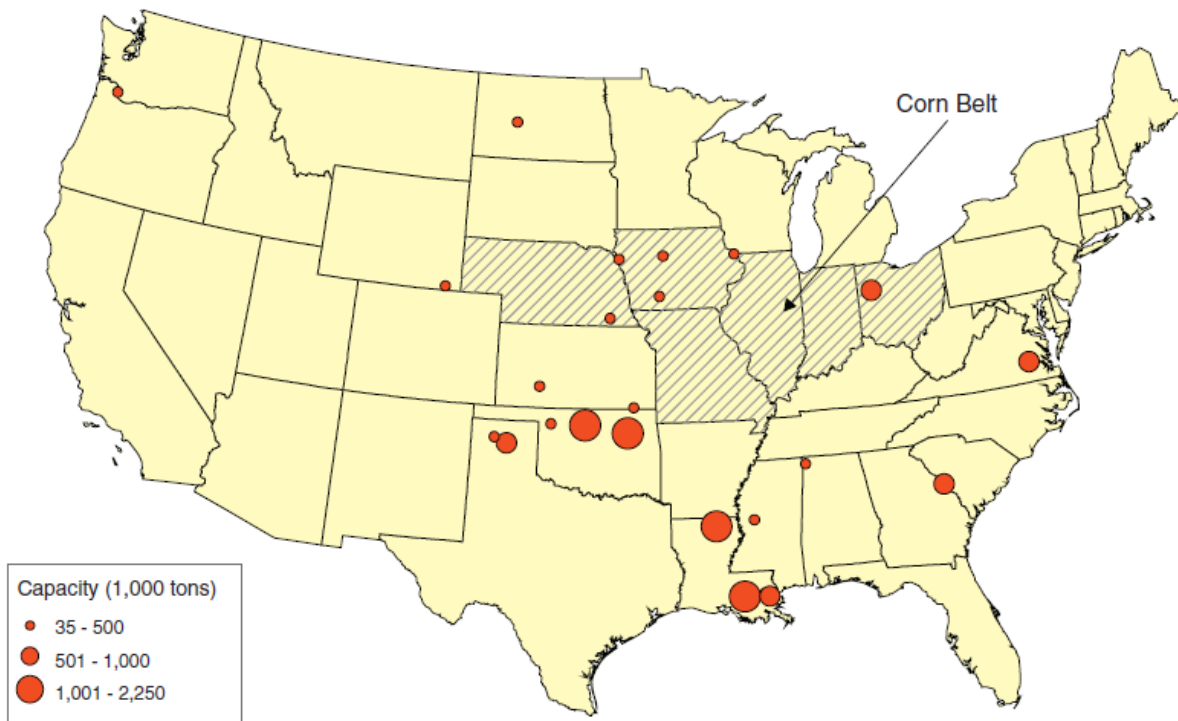

Figure 10: U.S. ammonia plant capacity in 2005/2006 (Huang, 2007).

Figure 11 shows the consumption of nitrogenous fertilizers per selected crop in the U.S. Corn production accounts for most nitrogenous fertilizer consumption, i.e., 46% in 2010, followed by the production of wheat with 11% (USDA, 2013).

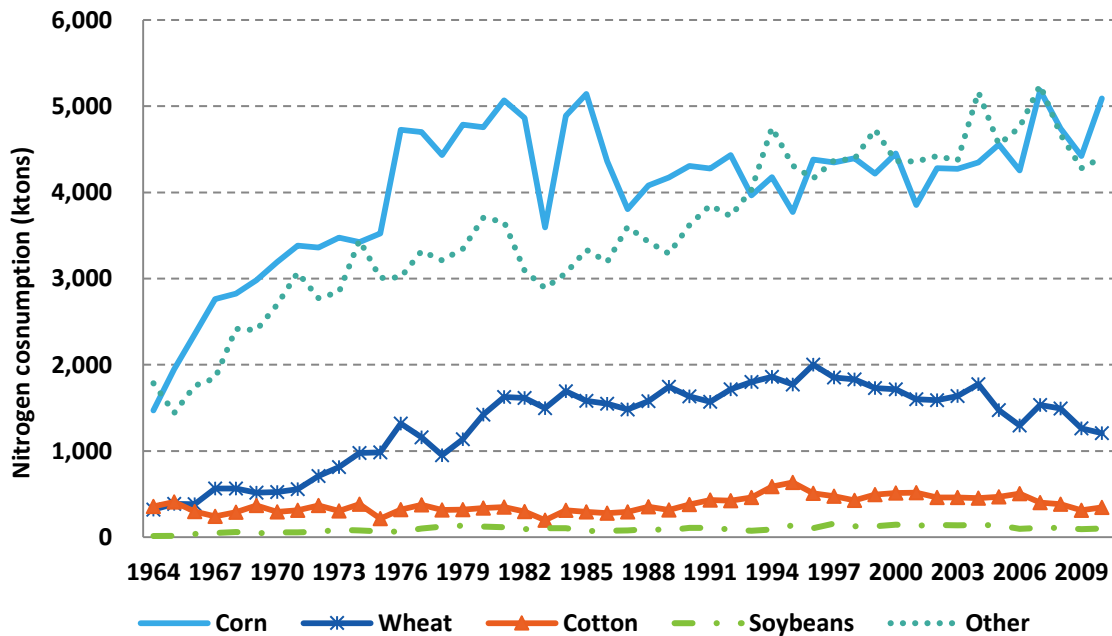

Figure 11: Use of nitrogenous fertilizers in the U.S. for selected crops (USDA, 2013).

Figure 12 shows the U.S. ammonia imports and exports, the accumulated stocks, and the ammonia production and apparent consumption<sup>9</sup> in the period 1945-2013 (USGS, 2015b). Up to the mid-1970s, domestic production satisfied almost the entire need for ammonia. Ammonia imports started to grow since the late 1970s. In 1980, about 11% of ammonia consumed was imported. Since then, import reliance has gradually increased with imports reaching 7.2 million tons (N) in 2005. In 2015, 5.5 million tons of ammonia (N) were imported. More than half of the ammonia imports were from Trinidad and Tobago (57%) followed by Canada (20%) and Russia (7%) (USGS, 2015a).

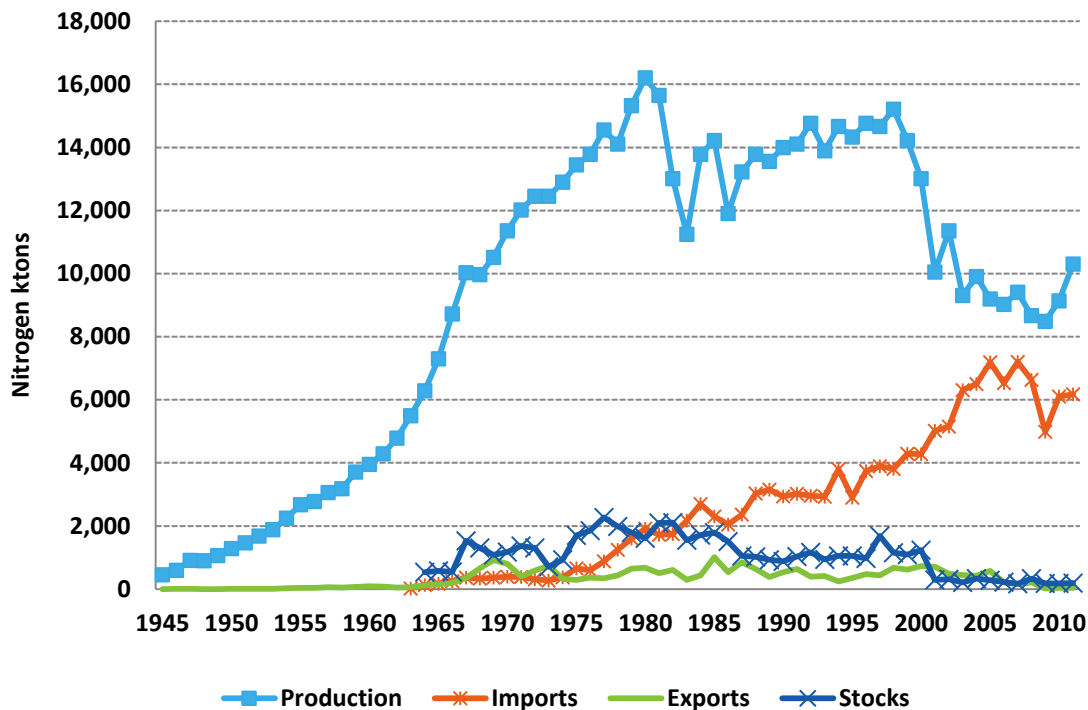

Figure 12: Annual ammonia imports and exports in the U.S. (Source: USGS, 2015b).

<sup>9</sup> Apparent consumption is defined as the ammonia production plus imports, minus exports.

## Process Description

### Ammonia (NH<sub>3</sub>)

Ammonia is produced by the reaction of hydrogen and nitrogen in the so-called Haber-Bosch process. There are two main hydrogen production processes used (EFMA, 2000a):

- **Steam/air reforming.** Feedstocks to this process include natural gas or other light carbon fuels such as natural gas liquids, liquefied petroleum gas, and naphtha.
- **Partial oxidation.** Feedstocks to this process include heavy feedstocks such heavy oils and coal.

The conventional steam reforming process is shown in Figure 13. The key difference between steam reforming and the partial oxidation production route is in the way synthesis gas is produced. Synthesis gas is primarily composed of H<sub>2</sub> and CO that is produced by the steam reforming or the partial oxidation of hydrocarbons. The other parts of the ammonia production process, from shift conversion to ammonia synthesis, are identical for both production routes, except for the liquid nitrogen wash in partial oxidation (and in cases where CO<sub>2</sub> and sulfur removal are integrated in a single unit) (IPTS/EC, 2007).

In general, producing ammonia with the partial oxidation process requires between 1.3 and 1.7 times more energy than ammonia production with the steam reforming process (IEA, 2007). In addition, coal-based ammonia plants emit large amounts of greenhouse gases (GHGs). Coal-based ammonia plants emit roughly 2.4 times the amount CO<sub>2</sub> emitted by a natural gas-based ammonia plant (IFA, 2009a).

Natural gas is the preferred feedstock for ammonia production, as it has the highest hydrogen to carbon ratio, leading to reduced energy consumption and lower CO<sub>2</sub> emissions. In the U.S., almost all ammonia plants use natural gas as feedstock. According to the 2010 Manufacturing Energy Consumption Survey (MECS) (EIA, 2013), in 2010, 99% of the feedstock use in the U.S. nitrogenous fertilizer industry was natural gas. The steam reforming process is described below.

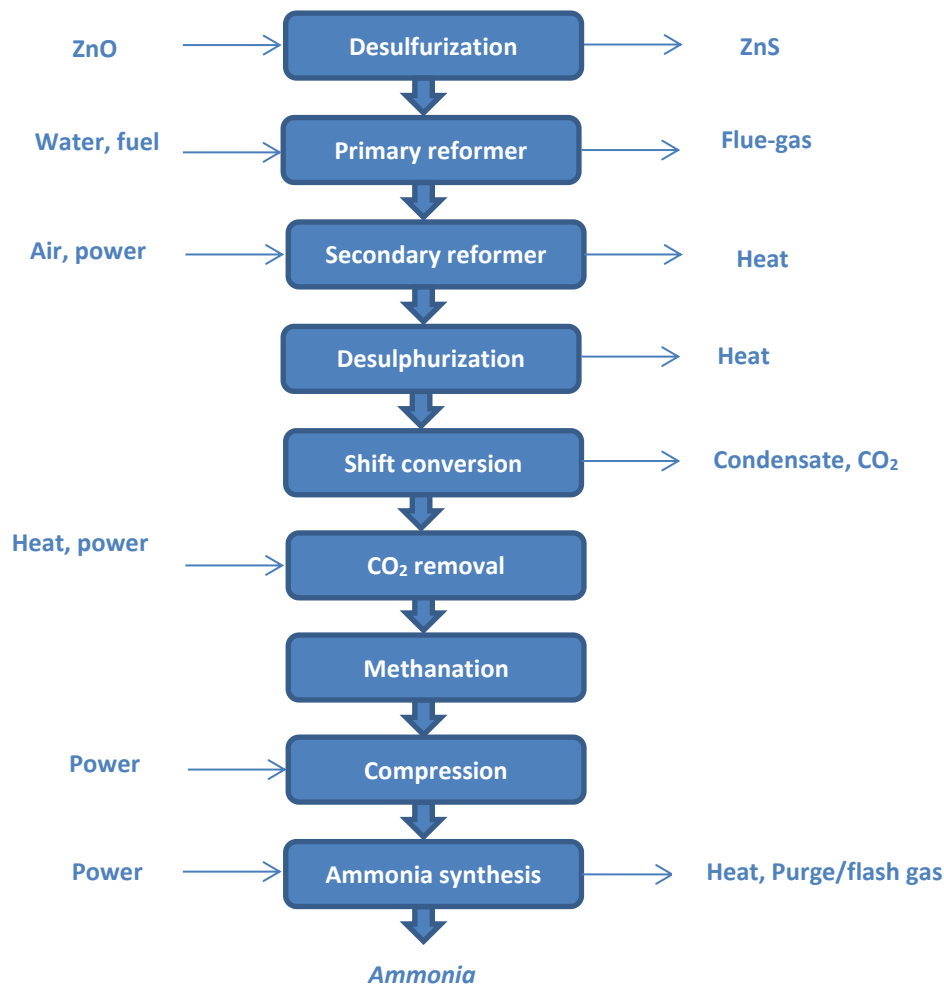
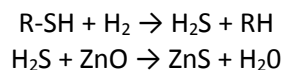

Figure 13: Conventional steam reforming (based on EFMA, 2000a).

## Desulfurization

The feedstock used to produce ammonia may contain sulfur. Sulfur compounds are harmful for the catalyst used in the process and need to be removed. In desulfurization, the pre-heated (662-752°F (350-400°C)) and untreated feed-gas enters a vessel that usually contains a cobalt-molybdenum catalyst, where the sulfur compounds are hydrogenated to H<sub>2</sub>S. The hydrogen needed for the reaction is usually recycled from the synthesis section. The hydrogenated sulfur compounds are then adsorbed on pelletized zinc oxide (IPTS/EC, 2007). After desulfurization, the feed-gas sulfur concentration drops to less than 0.1 ppm.



## Primary reforming

After desulfurization, the feed gas is mixed with process steam. The preheated mixture enters the primary reformer at a temperature of 752-1112°F (400-600°C). In some new and revamped ammonia plants, the preheated steam/gas mixture is passed through an adiabatic pre-reformer before entering the primary reformer, where it is then reheated in the convection section.

Primary reformers consist of many high-nickel chromium alloy tubes that are filled with a nickel-containing reforming catalyst. In conventional steam reforming, the hydrocarbon conversion rate in the primary reformer is about 60%. The reaction is highly endothermic:

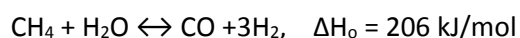

Natural gas burners provide heat to the process. About half of the heat supplied to the primary reformer is consumed in the reaction. The remaining half is contained in the flue gases and used in the convection section of the reformer for the preheating of process streams. The flue gas leaving the primary reformer convection section composes the most significant source of the plant's emissions. These emissions mainly consist of CO<sub>2</sub>, NO<sub>x</sub>, and very small amounts of SO<sub>2</sub> and CO (EFMA, 2000a).

The typical fuel use in the primary reformer (including steam generation) ranges between 6.8 and 8.5 MMBtu/ton of ammonia (IPTS/EC, 2007), excluding natural gas use for feedstocks. Natural gas consumption in efficient plants is about 6.4 MMBtu/ton of ammonia (Ullmann's, 2011).

## Secondary reforming

In secondary reforming, nitrogen is added and the reforming of the hydrocarbon feed is completed. To increase the conversion rate, high temperatures are required. This is achieved by combusting part of the reaction gas and process air, which is also the source of nitrogen, before it passes over the nickel catalysts. The supplied air is compressed and heated at the convection section of the primary reformer at a temperature of 932-1,112°F (500-600°C). The gas outlet temperature is about 1,800°F (1,000°C), and about 99% of the primary reformer hydrocarbon feed is converted. The residual methane content is about 0.2-0.3% (dry gas base). Heat is recovered in a waste heat boiler where the gas is cooled to approximately 626-716°F (330-380°C) (IPTS/EC, 2007).

## Shift conversion

The process gas exiting the secondary reformer contains 12-15% (dry gas base) of CO. In shift conversion, most of the CO will be converted to CO<sub>2</sub> and hydrogen:

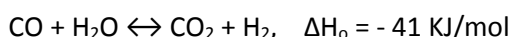

A low residual CO content is crucial for the efficiency of the process. Unconverted CO will consume hydrogen in the methanator, reducing the feedstock efficiency and increasing the inert gas content in the

### DID YOU KNOW?

**Natural gas consumption in efficient plants is about 6.4 MMBtu/ton of ammonia.**

synthesis loop. Therefore, the performance of the shift conversion section is important for the overall energy efficiency of the ammonia plant (Haldor Topsoe, 2012).

The reaction is conducted in two steps with heat removal steps in between. Initially, the process gas passes through a bed of iron oxide/chromium oxide catalyst at around 662-716°F (350-380°C) (high temperature shift (HTS) conversion) and then over a copper oxide/zinc oxide catalyst at around 392-428°F (200-220°C) (low temperature shift (LTS) conversion). The resulting process gas has a residual CO content of 0.2-0.4% (dry gas base). New developments can employ an isothermal shift one-step conversion (IPTS/EC, 2007).

The process gas exiting the LTS converter is cooled, and after most of the steam is condensed and removed, the gas passes through the CO<sub>2</sub> removal section. Recovered heat can be used for other purposes such as the regeneration of the CO<sub>2</sub> scrubbing unit (IPTS/EC, 2007).

The steam consumption in the shift conversion and the CO<sub>2</sub> removal processes is about 0.8-1.1 MMBtu/ton (see Table 9) and the electricity consumption is about 0.4 MMBtu/ton of ammonia (117 kWh/ton) (Worrell et al., 2000).

### CO<sub>2</sub> removal

In this process step, CO<sub>2</sub> is removed from the synthesis gas, using either physical or chemical absorption. The residual CO<sub>2</sub> content typically ranges between 50 and 3,000 ppm-v. In chemical absorption, the solvents used are mostly aqueous amine solutions (MEA and MDEA), or hot potassium carbonate solutions. In physical absorption, typical solvents are glycol dimethylethers (Selexol), propylene carbonates, and others (IPTS/EC, 2007). The heat requirements in a modern chemical absorption plant range between 30 and 60 MJ/kmol CO<sub>2</sub>. A physical absorption plant can be designed to have zero heat requirements, but would use electricity for the compressor (EFMA, 2000a).

### Methanation

After CO<sub>2</sub> removal there are still small amounts of CO and CO<sub>2</sub> that can poison the catalyst in the ammonia synthesis loop, and therefore need to be removed. In this process, CO and CO<sub>2</sub> are transformed into methane in a reactor over a nickel-containing catalyst. The reactions are the following:

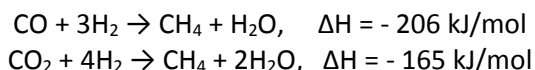

The water produced is removed before entering the converter, by cooling and condensation downstream of the methanator (IPTS/EC, 2007).

### Compression

The synthesis gas is compressed to high pressures, ranging from 100 to 250 bars, for the ammonia synthesis. Modern plants employ centrifugal compressors that are usually driven by steam turbines using internally produced steam (from excess process heat). The energy requirements in a modern steam reforming plant are 40-50% above the thermodynamic minimum. Compression losses are responsible for more than half of the excess energy use (EFMA, 2000a).

The steam requirements in the turbines used for driving the synthesis gas compressor, the air compressors and the refrigeration compressors are about 3.7-6.0 MMBtu/ton NH<sub>3</sub> (see Table 9).

### Ammonia synthesis

Ammonia synthesis takes place over an iron catalyst at a pressure of 100-250 bar and temperature of 662-1,022°F (350-550°C) (IPTS/EC, 2007):

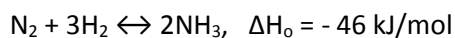

Due to unfavorable equilibrium conditions, only about 20-30% of the synthesis gas is converted to ammonia. The ammonia is separated by cooling/condensation. After the ammonia is removed, the unreacted gas is recycled in the converter and mixed with new synthesis gas.

As the exothermic reaction in the ammonia synthesis reactor proceeds with a decrease in volume, lower temperatures and higher pressures will favor the reaction. Controlling the catalyst temperature is important. One technique for temperature control is the subdivision of the catalyst into several layers to reduce the temperatures by adding cooled synthesis gas between the layers or indirectly by generating steam. (IPTS/EC, 2007)

Steam reforming with methanation as the final purification step, results in a gas with high inert content (unreacted methane and argon). The inert contents are controlled by purging gas from the ammonia synthesis loop reducing them to about 10-15%. The purge gas is scrubbed with water to remove ammonia, and then used as fuel in the primary reformer or for hydrogen recovery (IPTS/EC, 2007).

With the use of more active ammonia synthesis catalysts, such as cobalt-promoted iron and ruthenium, lower pressures can be used, resulting in lower (compression) energy use.

### Urea (CO(NH<sub>2</sub>)<sub>2</sub>)

Globally, urea is the most commonly used solid fertilizer. In the U.S., urea production accounts for 29% of the nitrogen compounds produced (USGS, 2015a). It typically contains 45-46% nitrogen (see Table 8). While global urea production increased, since 2000, U.S. urea production has decreased. The 2013 U.S. production was 2.8 million tons N, accounting for 3.2% of global production (USGS, 2015a; IFA, 2015). Figure 9 shows the U.S. historical urea production trends since 1995.



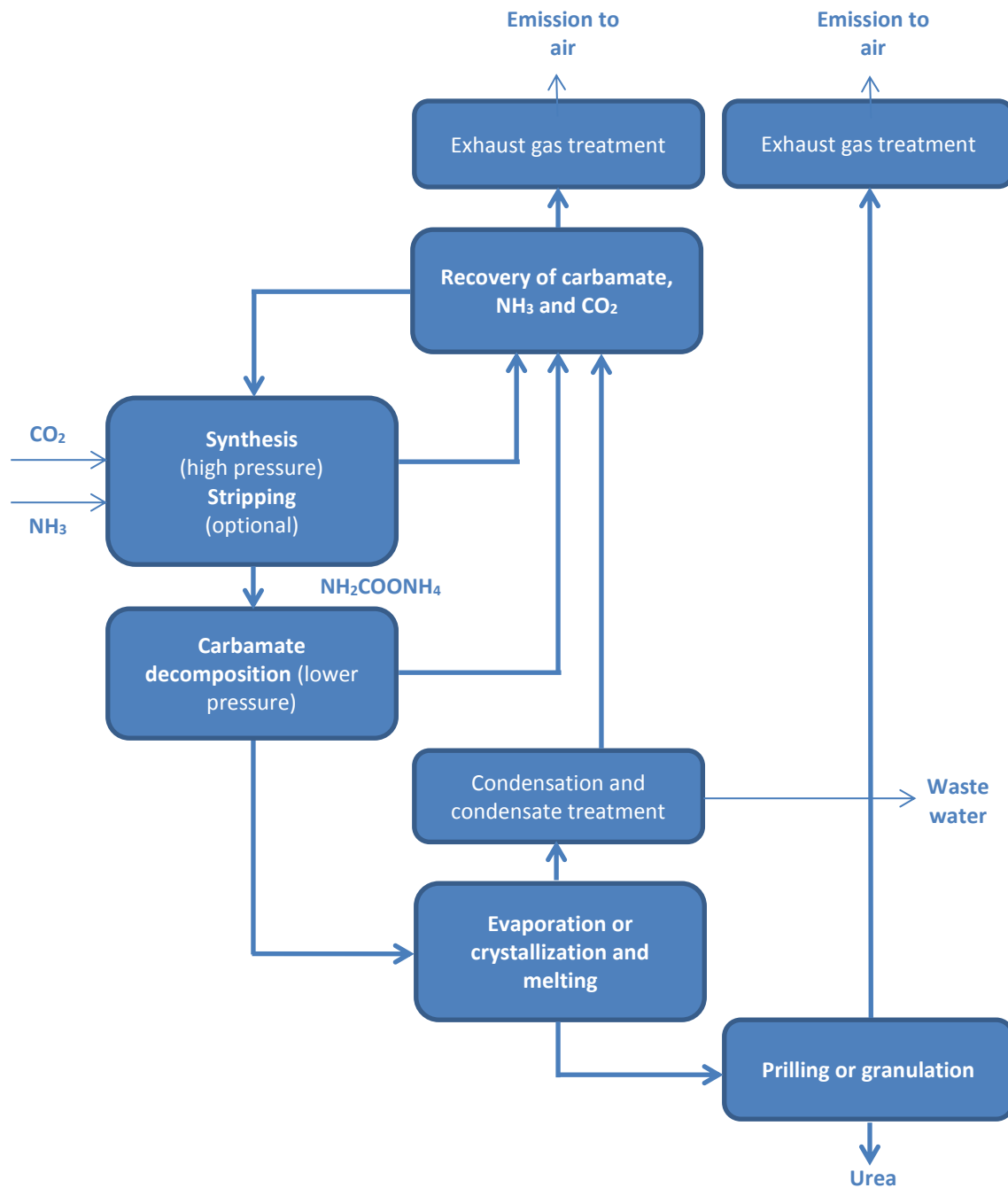
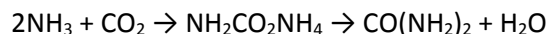

Figure 14: Urea production with the conventional recycle process (IPTS/EC, 2007).

## Urea Synthesis

In all commercial processes, urea is produced in two steps by the reaction of  $\text{NH}_3$  and  $\text{CO}_2$  at elevated temperature (356-374°F (180-190°C)) and pressure (140-200bar) (see Figure 14). In the first step,  $\text{CO}_2$  and

NH<sub>3</sub> are converted to ammonium carbamate (NH<sub>2</sub>CO<sub>2</sub>NH<sub>4</sub>) in an exothermic reaction. In the second step, by applying heat, NH<sub>2</sub>CO<sub>2</sub>NH<sub>4</sub> is dehydrated to produce urea and water.



The conversion of NH<sub>3</sub> and CO<sub>2</sub> to urea is not complete (50-80% CO<sub>2</sub> basis). The conversion efficiency increases with increased temperatures and NH<sub>3</sub>/CO<sub>2</sub> ratio, and decreases with increased H<sub>2</sub>O/CO<sub>2</sub> ratio (IPT/EC, 2007). Urea manufacturing processes mainly differ in the way non-converted NH<sub>3</sub> and CO<sub>2</sub> are handled (Meessen, 2010). The main processes are:

- *One-Through Processes* where all non-converted NH<sub>3</sub> and CO<sub>2</sub> is discharged to other plants where NH<sub>3</sub> is used in the production of ammonium sulfate and ammonium nitrate;
- *Conventional Recycle Processes (or Total Recycle Process)* where all of the non-converted NH<sub>3</sub> and CO<sub>2</sub> are recycled to the urea reactor; and
- *Stripping Processes* where the major part of the non-converted NH<sub>3</sub> and CO<sub>2</sub> is recycled via the gas phase, eliminating the need for water addition to the recycle, and thus avoiding the negative effect of water use on the conversion efficiency.

The urea plants are commonly situated next to ammonia plants, as the CO<sub>2</sub> extracted in ammonia manufacture can be used as CO<sub>2</sub> feedstock in urea production. When the ammonia facility does not generate enough CO<sub>2</sub> (depending on the production volumes of NH<sub>3</sub> and urea) extra CO<sub>2</sub> needs to be generated in a separate plant.

### Particle Formation

The urea solution produced in the synthesis cycle is then concentrated via evaporation or crystallization to form the final product in either a solid prilled or granular form (EFMA, 2000c).

*Prilling.* The concentrated urea melt is sprayed through a rotated spinning bucket with holes or showerheads from the top of a prilling tower. The urea droplets are solidified by the cooling air as they drop from the top of the tower. Main drawbacks of prilling are: the formation of fine dust, and the formation of urea particles with small size and limited shock resistance and crushing strength. In past plant designs, prilling was most often used in urea plants (Meessen, 2010).

*Granulation.* In the granulation method, the concentrated urea solution is sprayed on granules that gradually increase in size while drying. There are various types of granulation equipment; pan granulators, drum granulators, spouted-bed granulators, and fluidized-bed granulators (IPT/EC, 2007; Meessen, 2010). The granulation method results in larger urea particles than in prilling, while due to the shorter contact time between the liquid urea and cooling air, the formation of dust is coarser, and therefore easier to separate. Granulation does require higher investments and has higher variable costs (Meessen, 2010).

### Nitric Acid (HNO<sub>3</sub>)

Nitric acid (NA) production accounts for 17% of the nitrogen compounds produced in the U.S. (USGS, 2015a). It typically contains 22% nitrogen. It has a transparent yellow color and a sweet to pungent odor (UNIDO, 1979).

In 2013, the U.S. NA production reached 1.7 million tons N (USGS, 2015a). Figure 9 shows the U.S. historical NA production trend. Since 1995, U.S. NA production has more than tripled, increasing from 0.4 million tons N in 1995 to 1.7 million tons N by 2013.

Nitric acid is an intermediate product used in the manufacture of ammonium nitrate (AN), calcium nitrate (CN) and potassium nitrate that are used as straight fertilizers or mixed into compound fertilizers. NA is also used in the production of AN explosives and other industrial chemicals such as caprolactam and adipic acid (raw materials for nylon production). There are two different nitric acid production methods: the weak nitric acid (30-70% acid concentration) and the high-strength nitric acid (above 90% acid concentration) method (U.S. EPA, 2010). The fertilizer industry uses the weak nitric acid process with an acid concentration ranging between 50 and 65% (UNEP, 1998). Currently in the U.S., there are forty active weak nitric acid plants and one high-strength nitric acid plant. Most of them were built between 1960 and 2000 (U.S. EPA, 2010).

In the weak nitric acid production process, three high-temperature catalytic reactions take place. Initially, ammonia is oxidized with air on a catalyst to produce nitric oxide (NO) (first reaction). The catalyst consists of woven or knitted gauzes composed of about 90% platinum alloyed with rhodium (10%)

and sometimes also palladium (up to 5%) (IPTS/EC, 2010; U.S. EPA, 2010). The heat produced during the exothermic reaction is recovered and used to produce steam and/or preheat the tail gas. The NO produced from the oxidation of ammonia is then oxidized as the mixture is cooled (second reaction). In the final step, nitrogen dioxide (NO<sub>2</sub>) comes in contact counter currently with water in the absorption column to form HNO<sub>3</sub> and NO (third reaction). The total process is highly exothermic and waste heat boilers are usually used to generate superheated pressurized steam.

One of the co-products of ammonia oxidation is nitrous oxide (N<sub>2</sub>O), a gas with high Global Warming Potential (GWP) of 298 times that of CO<sub>2</sub> (100 year time horizon) (Forster et al., 2007). Various control technologies exist to virtually eliminate N<sub>2</sub>O emissions from nitric acid plants. Various European plants use these control technologies with reductions of up to 96-98 %.

Depending on the pressures utilized, there are two types of weak nitric acid plants; *single pressure*, the most common plant type, where oxidation and absorption pressures are the same, and *dual pressure* where absorption pressure is higher than the oxidation pressure (UNEP, 1998). Producers prefer the dual pressure method for new plants as the conversion efficiency is higher and the catalyst lifetime is longer (U.S. EPA, 2010).

Ammonia oxidation at atmospheric pressures has the lowest N<sub>2</sub>O emissions at 6-8 lb. N<sub>2</sub>O/ton NA (3-4 kg N<sub>2</sub>O/tonne). At medium pressures emissions are higher at 10-16 lb. N<sub>2</sub>O/ton NA (5-8 kg N<sub>2</sub>O/tonne), while high pressure plants have the highest N<sub>2</sub>O emission levels of about 40 lb. N<sub>2</sub>O/ton NA (20 kg N<sub>2</sub>O/tonne) (Groves et al., 2006b).

#### DID YOU KNOW?

**Technologies exist to nearly eliminate N<sub>2</sub>O emissions from nitric acid plants. European plants use them for reductions of up to 98%.**

## Ammonium Nitrate (NH<sub>4</sub>NO<sub>3</sub>)

Ammonium nitrate (AN) accounts for 28% of the nitrogen compounds produced in the U.S. (USGS, 2015a) and about 75% of U.S. nitric acid consumption (USGS, 2004). AN typically contains 34% nitrogen.

U.S. AN production decreased from 3.0 million tons N in 1995 to 2.8 million tons N in 2013, an overall decrease of 8%. In 2013, the U.S. accounted for 15% of global AN production (USGS, 2015a; IFA, 2015). Figure 9 depicts historical U.S. AN production.

Ammonium nitrate can be used as a straight fertilizer or it can be combined with dolomite, calcium carbonate, or limestone to form calcium ammonium nitrate (CAN). Main steps for AN production are:

- i) neutralization of aqueous HNO<sub>3</sub> with gaseous NH<sub>3</sub> in a highly exothermic reaction where ammonium nitrate solution (ANS) and steam is produced;
- ii) concentration of ANS in an evaporator to the required water content depending on the type of solidification, and;
- iii) product solidification (prilling or granulation).

AN is mainly marketed in the solid form, however, due to the increased use of ammonium nitrate in urea-ammonium nitrate (UAN) manufacture, about half of the AN is marketed in the U.S. as a solution (USGS, 2004).

## Ammonium Sulfate [(NH<sub>4</sub>)<sub>2</sub>SO<sub>4</sub>]

Ammonium sulfate (AS) accounts for 8% of the nitrogen compounds produced in the U.S. (USGS, 2015a). It typically contains 21% nitrogen. Ammonium sulfate has been replaced with fertilizers with higher nitrogen content such as ammonium nitrate and urea. Due its high sulfur content (45%), it is mainly applied in soils deficient in sulfur (USGS, 2004).

U.S. ammonium sulfate production increased from 0.6 million tons N in 1995 to 0.8 million tons N in 2013; an increase of 31%. In 2013, the U.S. accounted for 14% of global production (USGS, 2015a; IFA, 2015). The historical U.S. ammonium nitrate production trends since 1995 are shown in Figure 9.

There are several methods used to produce ammonium sulfate with the most prominent being:

- Direct synthesis from ammonia and sulfuric acid;
- Synthesis from different coke-oven byproduct gases; or,
- Recovery from industrial by-product liquors.

Due to its high availability as a byproduct, the direct synthesis process is not often used (USGS, 2004). The most common source of ammonium sulfate is caprolactam production. In caprolactam manufacture, the initially produced caprolactam sulfate is hydrolyzed with ammonia to produce caprolactam and ammonium sulfate. For every ton of caprolactam produced, 1.8-5.0 tons of ammonium sulfate are produced as a byproduct (UNIDO, 1979; USGS, 2004).

## Appendix B: Energy Consumption by Fertilizer Type

The nitrogenous fertilizer industry is a large energy consumer. Ammonia production is the most energy intensive step, accounting for 80-90% of the energy used in the fertilizer industry. This chapter gives an overview of the energy consumed in the production of the main nitrogenous fertilizers.

### Energy Use in Ammonia Production

In steam reforming ammonia plants, there is a surplus of high-level heat that is produced in primary reforming, secondary reforming, shift conversion, and ammonia synthesis. Most of the heat is recovered for producing high pressure steam used in turbines for driving compressors. In general, all high pressure steam will be used in steam turbines to drive the synthesis gas compressor. State-of-the-art steam reforming ammonia plants do not import energy to drive the mechanical equipment. Energy can be exported in the form of steam or electricity.

Figure 15 shows the development of energy use in ammonia plants since 1955. In the mid-1950s, plant design efficiency was at 58 MMBtu/ton NH<sub>3</sub> (62 GJ/tonne NH<sub>3</sub>).<sup>10</sup> With continuous improvement in plant designs, and the adoption of energy efficiency measures and advanced technologies, plant design energy consumption has dropped to 26 MMBtu/ton NH<sub>3</sub> (28 GJ/tonne NH<sub>3</sub>) - half the energy use per ton of ammonia consumed 50 years ago. IFA benchmarking data show that best-in-class ammonia plants consume about 29 MMBtu/ton NH<sub>3</sub> (IFA, 2009a).

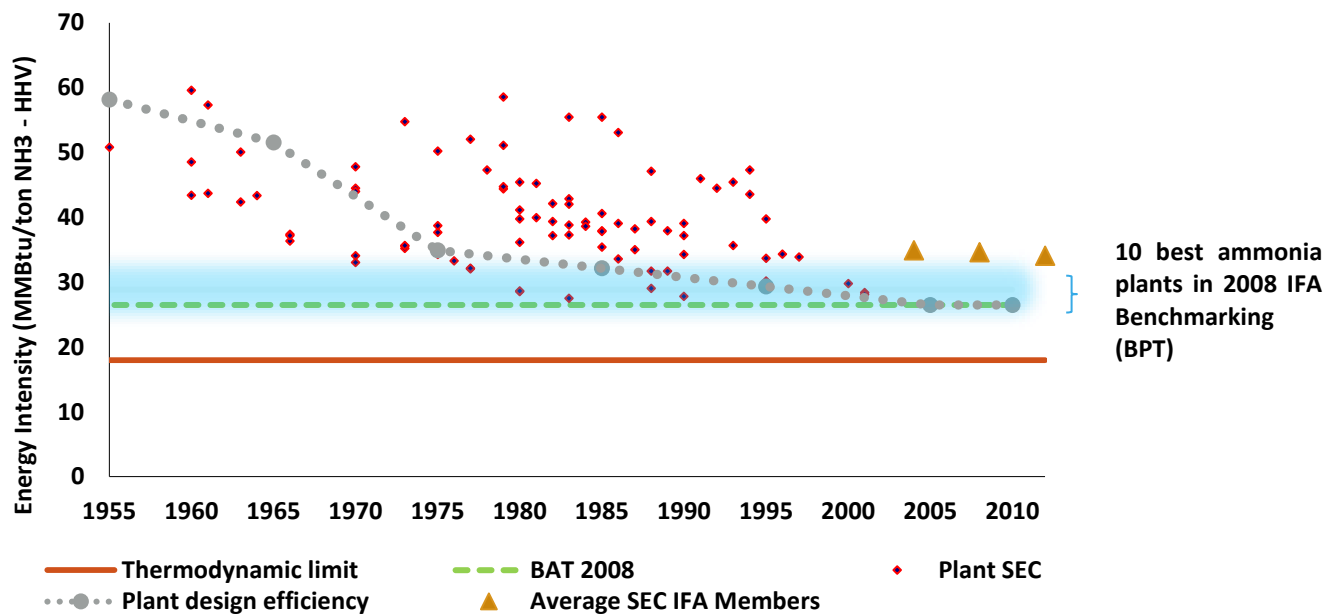

Figure 15: Development of the specific energy consumption of ammonia plants over the period 1955-2010 (IFA personal communication; IFA, 2009a; IFA, 2014; Bernstein et al., 2007).

<sup>10</sup> The heating value of a fuel can be expressed in lower (or net) heating value (LHV) and higher (or gross) heating value (HHV). The difference is the condensation heat of water vapor generated in the combustion process, which is included in the HHV. LHV is commonly used in international statistics and in Europe, while HHV is used in the U.S. and Canada. In this guide, unless otherwise indicated, values are given in HHV. In parenthesis, energy use is reported in GJ/tonne LHV.

Natural gas use in a typical ammonia plant using the steam reforming process ranges between 26.6 and 33.6 MMBtu/ton, of which about 19-21 MMBtu/ton of ammonia is used as feedstock, 6.8-8.5 MMBtu/ton is fuel in the primary reformer, and most of the remaining fuel, 0.5-4.0 MMBtu/ton, powers auxiliary boilers. Table 9 shows the typical breakdown of energy use in steam reforming ammonia plants.

Table 9. Estimated energy use breakdown for a typical ammonia plant using natural gas as a feedstock (based on Worrell et al., 2000 and Ecofys, 2013).

	GJ/tonne NH <sub>3</sub> - LHV		MMBtu/ton NH <sub>3</sub> – HHV	
	Natural Gas	Heat input/output <sup>1</sup>	Natural Gas	Heat input/output <sup>1</sup>
<b>Primary reformer feed</b>	20.4 - 22.3		19.3 - 21.1	
<b>Primary reformer</b>	7.2 - 9.0	3.0 - 4.5	6.8 - 8.5	2.8 - 4.3
<b>Secondary reformer</b>		0.0		0.0
<b>Waste heat boiler</b>		-5.0 - -6.0		-4.7 - -5.7
<b>Shift and CO<sub>2</sub> removal</b>		0.8 - 1.2		0.8 - 1.1
<b>Methanator</b>				
<b>Synthesis loop</b>		-2.5 - -3.0		-2.4 - -2.8
<b>Auxiliary boiler</b>	0.3 - 3.5	-0.2 - 3.0	0.3 - 3.3	-0.2 - 2.8
<b>Turbines/compressors</b>		3.9 - 6.3		3.7 - 6.0
<b>Other (e.g. flare)</b>	0.2 - 0.7		0.2 - 0.7	
<b>Total</b>	<b>28.1 - 35.5</b>	<b>0.0</b>	<b>26.6 - 33.6</b>	<b>0.0</b>

<sup>1</sup> The heat generated in waste heat boilers, in the synthesis loop and in auxiliary boilers is presented with negative values.

Advanced steam reforming configurations, currently considered as Best Available Technologies (BAT) are (Ullmann's, 2011; ITSP/EC, 2007):

- Advanced conventional primary reforming with high-duty primary reforming and stoichiometric process air in the secondary reformer. Processes with this configuration are the Kellogg Low-Energy Ammonia Process, the Haldor Topsoe, the Uhde, the LEAD, the Exxon Chemical, the Fluor, and the Lummus processes.
- Steam reforming with mild conditions in the primary reformer and use of excess air in the secondary reformer. Processes with this configuration are the Braun Purifier, the ICI AMV, e Foster Wheeler AM2, the Humphreys & Glasgow BYAS, Jacob Plus Ammonia Technology the Montedison Low-pressure, and the Kellogg's LEAP processes.
- Heat exchange autothermal reforming with a process gas heat exchange reformer and a separate secondary reformer, or in combination with an autothermal reformer that uses excess or enriched air. Processes with this configuration are the ICI LCA and the Chiyoda processes.

The claimed energy intensity of the different processes is shown in Table 10.

Table 10. Comparison of energy use in the various advanced steam reforming configurations (Ullmann's, 2011).

	Energy Use (GJ/tonne NH <sub>3</sub> ) – LHV	Energy Use (MMBtu/ton NH <sub>3</sub> ) - HHV
<b>Advanced conventional primary reforming</b>		
Kellogg Low-Energy Ammonia Process	27.9 (27.0 <sup>1</sup> )	26.4 (25.5 <sup>1</sup> )
Haldor Topsoe Process	27.9	26.4
Uhde Process	28.0 (27.0 <sup>1</sup> )	26.5 (25.5 <sup>1</sup> )
LEAD Process	29.3	27.7
Exxon Chemical Process	29.0	27.4
Fluor Process	32.0	30.3
Lummus Process	29.6-33.5	28.0-31.7
<b>Processes with reduced primary reformer firing</b>		
Braun Purifier Process	28.0 (27.0 <sup>1</sup> )	26.5 (25.5 <sup>1</sup> )
ICI AMV Process	28.5	27.0
Foster Wheeler AM2 Process	29.3	27.7
Humphreys & Glasgow BYAS Process	28.7	27.1
Jacobs Plus Ammonia Technology	28.8 (26.8 <sup>1</sup> )	27.2 (25.3 <sup>1</sup> )
Montedison Low-Pressure Process	28.1	26.6
Kellogg's LEAP Process	<28.0	<26.5
<b>Processes without a primary reformer</b>		
ICI LCA Process	29.3	27.7
Kellogg Brown and Root (KBR) KAAPplus Process	27.2	25.7
Chiyoda Process	N/A	N/A
<b>Processes without a secondary reformer</b>		
KTI PARC Process	29.3-31.8	27.7-30.1
Linde LAC Process	28.5 (29.3 <sup>2</sup> )	27.0 (27.7 <sup>2</sup> )
Humphreys & Glasgow MDF Process	32.8 <sup>2</sup>	31.0 <sup>2</sup>

<sup>1</sup> Energy use when steam is exported.

<sup>2</sup> Energy use when CO<sub>2</sub> is recovered.

## Energy Use in Urea Production

The energy intensity of a conventional urea total recycling plant is about 5.2 MMBtu/ton urea. Adopting CO<sub>2</sub> stripping can reduce the energy use to about 3.6-3.7 MMBtu/ton urea. In a modern total recycling process plant, the conversion of ammonia to solid urea consumes about 3.1 MMBtu/ton urea (3.3 GJ/tonne urea). Advanced CO<sub>2</sub> stripping processes such as the Stamicarbon and the ACES-process have an energy use of about 2.6 MMBtu/ton urea. IFA (2009b) considers energy use of 3.5 MMBtu/ton urea (3.7 GJ/tonne urea) as best practice and 3.0 MMBtu/ton (3.2 GJ/tonne) urea as best available technology. Table 11 shows the reported energy use in different types of urea plants.

Table 11. Reported overall energy use (late 1990s and early 2000s data) for urea production (IPTS/EC, 2007).

Process (remarks)	Energy use (GJ/tonne urea)-LHV <sup>1</sup>	Energy use (MMBtu/ton urea)-HHV <sup>1</sup>
<b>Conventional total recycle process</b>		
Conventional total recycle process (Toyo) (excl. electricity use for CO <sub>2</sub> compression)	2.7	2.6
Existing installations (crystallization, natural draft prilling, compression with steam turbine)	5.5	5.2
<b>NH<sub>3</sub> stripping</b>		
Snamprogetti NH <sub>3</sub> stripping (excl. electricity use for CO <sub>2</sub> compression)	1.7	1.6
NH <sub>3</sub> stripping (prilling, CO <sub>2</sub> compression with steam turbine, prilling)	2.9	2.7
NH <sub>3</sub> stripping (prilling, CO <sub>2</sub> compression with steam turbine, granulation)	3.1	2.9
NH <sub>3</sub> stripping (prilling, CO <sub>2</sub> compression with electromotor, prilling)	2.0	1.9
NH <sub>3</sub> stripping (prilling, CO <sub>2</sub> compression with electromotor, granulation)	1.9	1.8
<b>CO<sub>2</sub> stripping</b>		
Stamicarbon CO <sub>2</sub> stripping, (excl. electricity use for CO <sub>2</sub> compression)	1.9	1.8
Stamicarbon CO <sub>2</sub> stripping, (steam and electricity)	2.7	2.6
ACES stripping (spout fluid bed granulation, CO <sub>2</sub> /NH <sub>3</sub> /carbamate pumps driven by steam turbine)	3.0	2.8
ACES stripping (spout fluid bed granulation, only the CO <sub>2</sub> pump driven by steam turbine)	2.7	2.6

<sup>1</sup> Total energy use takes into account steam and electricity imports and exports

## Energy Use in Nitric Acid Production

The NA production process is highly exothermic, generating more energy than consumed. Theoretically, NA production generates 5.4 MMBtu/ton NA (6.3 GJ/tonne) at 100% NA. However, due to losses in gas compressors and cooling water systems, less energy can be exported. The average net export of European NA plants was -1.3 MMBtu/ton NA (-1.6 GJ/tonne). Lako (2009) reports the results of a benchmarking study (83 nitric acid plants), according to which 43% of the plants were net exporters of energy. Best plants in the survey produced 1.6 MMBtu/ton NA (1.83 GJ/tonne), while the worst plants used 3.3 MMBtu/ton NA (3.8 GJ/tonne). Per the IFA (2009b), the energy use in best practice plants is -2.0 MMBtu/ton NA (-2.3 GJ/tonne), while best available technology consumes -2.7 MMBtu/ton NA (-3.1 GJ/tonne).

## Energy Use in Ammonium Nitrate Production

Heat produced during AN production is used to generate steam. The steam can be used to preheat the nitric acid or in the concentration of the AN solution (IPTS/EC, 2007). According to the IPTS/EC (2007), the average net energy use of European AN plants is about 0.6 MMBtu/ton AN (0.7 GJ/tonne). In new plants, energy use ranges between 0.08 and 0.19 MMBtu/ton AN (0.09-0.22 GJ/tonne). The energy use in CAN plants is slightly higher as an additional 0.03-0.15 MMBtu/ton CAN (0.036-0.18 GJ/tonne) is needed for raw material (e.g., dolomite and limestone) grinding. According to the IFA (2009b), the net energy use in best practice plants is 0.4 MMBtu/ton AN (0.5 GJ/tonne), while plants using best available technology have net zero energy use.



## Appendix C: Energy Use and Intensity in the U.S. Ammonia Industry

Over 80% of the energy consumed in the nitrogenous fertilizer industry is for ammonia production. The next energy consuming process is urea production. Nitric acid and ammonium nitrate are produced in highly exothermic processes.

The energy intensity of the U.S. ammonia industry cannot be directly calculated since the energy consumption reported in MECS concerns the nitrogenous fertilizer industry as a whole. According to the MECS (EIA, 2013), in 2010, the nitrogenous fertilizer industry consumed 154 TBtu (148 PJ) in fuels and 12 TBtu (13 PJ) in electricity. According to USGS (2012), in 2010, 7.8 million tons N of ammonia were produced for fertilizer purposes; that is about 9.6 million tons of ammonia (NH<sub>3</sub>). Hence, fuel use is estimated at 13.7 MMBtu/ton ammonia (14.5 GJ/tonne ammonia), excluding feedstocks. In 2010, 204 TBtu (196 PJ) of natural gas was consumed as feedstock (EIA, 2013), equal to 21.3 MMBtu/ton ammonia (22.6 GJ/tonne ammonia). Overall fuel use in the U.S. ammonia industry is estimated at 35 MMBtu/ton ammonia (37 GJ/tonne ammonia).

### DID YOU KNOW?

**Over 80% of the energy consumed in nitrogenous fertilizer production is for ammonia production. Adoption of available technology could reduce energy consumption by 14%.**

Table 12 shows the energy balance in U.S. ammonia plants estimated based on the typical energy use breakdown shown in Table 9.

Most of the fuel is consumed in the primary reformer (about 78%) and the remaining in auxiliary boilers. The heat from the waste heat boilers, synthesis loop, and auxiliary boiler is mostly used in the turbines (about 50%) and the primary reformer (about 40%).

Table 12. Estimated energy balance in the U.S. ammonia manufacturing industry (2010).

	(GJ/tonne NH <sub>3</sub> )-LHV		(GJ/tonne NH <sub>3</sub> )-HHV		(MMBtu/ton NH <sub>3</sub> )-HHV	
	Natural Gas	Heat input/output	Natural Gas	Heat input/output	Natural Gas	Heat input/output
Primary reformer feed	22.6	0.0	24.8	0.0	21.3	0.0
Primary reformer	11.2	4.0	12.3	4.4	10.6	3.8
Secondary reformer	0.0	0.0	0.0	0.0	0.0	0.0
Waste heat boiler	0.0	-5.5	0.0	-6.1	0.0	-5.2
Shift and CO <sub>2</sub> removal	0.0	1.1	0.0	1.2	0.0	1.0
Methanator	0.0	0.0	0.0	0.0	0.0	0.0
Synthesis loop	0.0	-2.8	0.0	-3.0	0.0	-2.6
Auxiliary boiler	2.6	-2.3	2.9	-2.3	2.5	-1.9
Turbines/compressors	0.0	5.4	0.0	6.0	0.0	5.1
Other (e.g. flare)	0.6	0.0	0.7	0.0	0.6	0.0
<b>Total</b>	<b>37.0</b>	<b>0.0</b>	<b>40.7</b>	<b>0.2</b>	<b>35.0</b>	<b>0.2</b>
<b>BPT (IFA, 2009a)</b>	<b>32.0</b>	-	<b>35.2</b>	-	<b>30.3</b>	-
<b>BAT (IFA, 2009a)</b>	<b>28.0</b>	-	<b>30.8</b>	-	<b>26.5</b>	-

Note: boiler efficiency assumed equal to 78% (HHV) and 86% (LHV)

In an earlier study, Worrell et al. (2000) estimated the 1999 fuel use in the U.S. ammonia industry at 33.4 MMBtu/ton; 13.9 MMBtu/ton for energy and 19.4 MMBtu/ton feedstock. This study estimates a slightly lower fuel use for energy of 13.7 MMBtu/ton.

According to the IFA (2009a) benchmarking study, in 2008, the average energy intensity in 93 ammonia plants was 34.6 MMBtu/ton (36.6 GJ/tonne). The energy use of the best performers (top quartile) ranged between 26.5-31.2 MMBtu/ton (28.0 and 33.0 GJ/tonne). The best practice for the top quartile natural gas-based plants was 30.3 MMBtu/ton (32.0 GJ/tonne ammonia). ***This indicates that wide adoption of the best practice technology (BPT) by U.S. ammonia producers has the potential to decrease the energy use by 14%.*** The energy use of best available technology (BAT) is 26.5 MMBtu/ton. Full implementation would result in 24% energy savings.

## Appendix D: GHG Emissions from the U.S. Nitrogenous Fertilizer Industry

### N<sub>2</sub>O Emissions from Nitric Acid Production

Nitric acid production is a source of industrial process greenhouse gas emissions. During ammonia oxidation, nitrous oxide (N<sub>2</sub>O) can be formed as a co-product of the reaction. The amount of N<sub>2</sub>O emitted depends on combustion conditions (pressure, temperatures), catalyst composition, catalyst age, burner design (EFMA, 2000b) and the emission abatement technologies adopted (see Table 13).

Table 13. IPCC default N<sub>2</sub>O emission factors for nitric acid production (IPCC, 2006).

Method	Pressure (atm)	N <sub>2</sub> O emissions (lb N <sub>2</sub> O/ton HNO <sub>3</sub> )		
		low	average	high
Low pressure plants	1	9.0	10.0	11.0
High pressure plants	4-8	11.2	14.0	16.8
Dual pressure plants	8-14	10.8	18.0	25.2
Plants with NSCR <sup>1</sup>		3.8	4.0	4.2
Plants with process integrated or tail gas N <sub>2</sub> O destruction		4.5	5.0	5.5

U.S. EPA (2009) estimated that in 2006, the U.S. nitric acid industry emitted 19.5 million tons CO<sub>2-eq</sub> of N<sub>2</sub>O; an N<sub>2</sub>O emission factor of 2.7 tons CO<sub>2-eq</sub>/ton HNO<sub>3</sub> (18.0 lb. N<sub>2</sub>O/ton HNO<sub>3</sub>). This estimate was based on the 2006 production levels of all U.S. nitric acid production facilities, the type of N<sub>2</sub>O abatement technology applied, and the IPCC default emission factors. In 2006, 17% of the nitric acid processes in the U.S. employed Selective Catalytic Reduction (SCR), while 5% of the processes employed Non-Selective Catalytic Reduction (NSCR).

Appendix G shows the 2006 production, capacity, and the types of N<sub>2</sub>O abatement technologies in operation in all nitric acid plants in the U.S.

In 2012, the U.S. nitric acid industry produced 7.5 million tons (gross weight) (~1.7 million tons N content) of nitric acid. For an emission factor of 2.7 tons CO<sub>2-eq</sub>/ton HNO<sub>3</sub> (same as in 2006), it is estimated that in 2012 the U.S. nitric acid industry emitted 20.3 million tons CO<sub>2-eq</sub> of N<sub>2</sub>O (~ 68 tons N<sub>2</sub>O).

### CO<sub>2</sub> Emissions

Carbon dioxide emissions can be estimated by multiplying the industry's fuel and electricity consumption with the specific emission factors.<sup>11</sup> Part of the CO<sub>2</sub> generated in ammonia production is captured and used as feedstock in urea production.<sup>12</sup> In 2010, the U.S urea production reached 5.6 million tons (in tons of urea) (USGS, 2012). About 20% of urea is carbon, thus we estimate that in 2010, 4.2 million tons CO<sub>2</sub>

<sup>11</sup> The emission factor of natural gas is 53.1 kg CO<sub>2</sub>/MMBtu.

<sup>12</sup> It should be noted that the CO<sub>2</sub> is released to the atmosphere when urea is applied in the field.

(1.13 million tons C) were used in urea production.<sup>13</sup> There is no information regarding the amount of CO<sub>2</sub> recovered for other purposes. It is estimated that the U.S. nitrogenous fertilizer industry emitted 15.5 million tons CO<sub>2</sub> in 2010.

---

<sup>13</sup> To meet peak CO<sub>2</sub> demands in urea production, back-up carbon dioxide generators are used (Worrell et al., 2000). If extra CO<sub>2</sub> generation was considered CO<sub>2</sub> consumption in urea manufacture would be higher.

## Appendix E: U.S. Ammonia Production Costs

The highest cost for ammonia producers is natural gas. Depending on the size of the ammonia plant and the price of natural gas, natural gas costs account for 72-85% of overall production costs [(TFI, 2005) as found in Huang (2007)]. In 2012, it is estimated that natural gas costs for U.S. ammonia producers amounted to \$78/ton ammonia.

Figure 16 shows the historical development of U.S. ammonia production capacity and the development of natural gas prices (USGS, various years). Ammonia capacity increased from 16.8 million tons NH<sub>3</sub> in the 1970s to 21.5 million tons NH<sub>3</sub> in 1978. It then suffered a dramatic decrease in the 1980s primarily as the result of the energy crisis and the recession. In the 1990s, ammonia capacity recovered and peaked at 19.7 million tons NH<sub>3</sub> in 1998 to yet suffer another low by 2006 of 14.0 million tons NH<sub>3</sub>. In 2011, ammonia production capacity had slightly increased to 14.2 million tons NH<sub>3</sub>. In general, ammonia production follows natural gas prices, although with a bit of a delay (USGS, 2004).

In recent years, due to the growing shale gas production, natural gas prices have decreased. The low natural gas prices increase the competitiveness of U.S. ammonia plants. Several companies have started or announced plant upgrades, while some even consider installing new green field capacity (USGS, 2012).

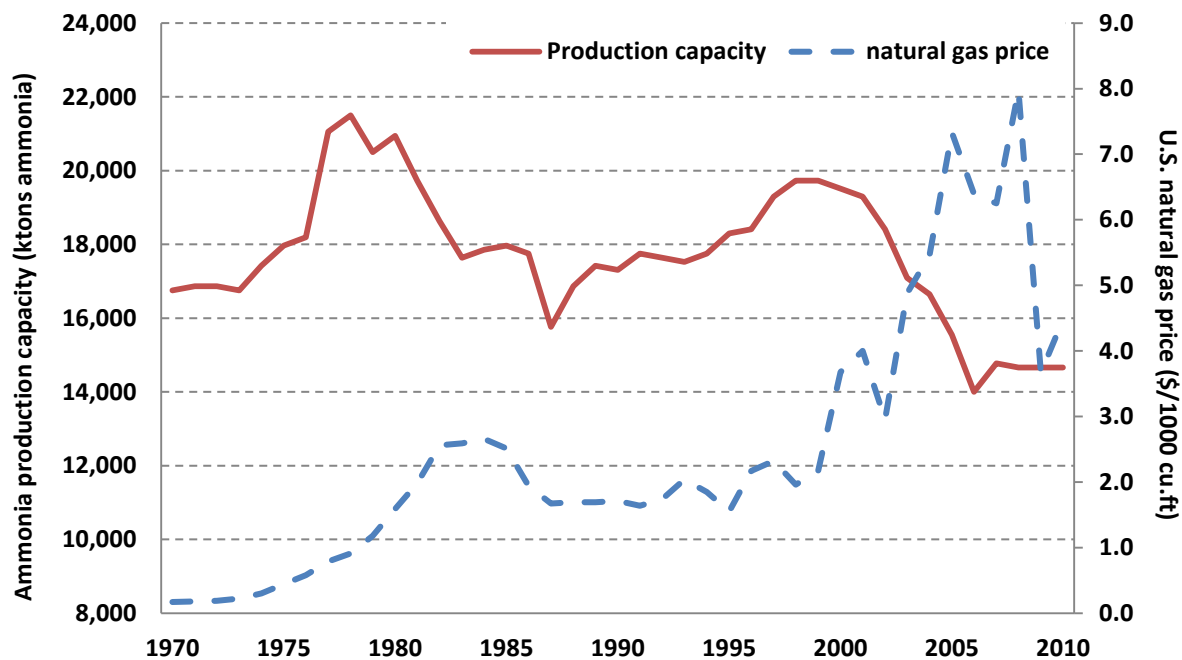

Figure 16: Historical U.S. ammonia production capacity and natural gas prices (Source: USGS, various years).

As ammonia producers are highly dependent on natural gas prices, to be able to withstand future price fluctuations, new plants should use energy-efficient state-of-the-art technologies. For older and inefficient plants to remain competitive at higher natural gas prices, retrofitting opportunities should be assessed.

## Appendix F: U.S. Ammonia Plants

Table 14. U.S. producers of anhydrous ammonia in 2013 (USGS, 2015a).

Company	Location	Capacity (1,000 tons ammonia)
<b>Agrium Inc.</b>	Borger, TX	540
	Kenai, AK	310
	Kennewick, WA	200
<b>CF Industries Holdings, Inc.</b>	Donaldsonville, LA	2,750
	Port Neal, IA	370
	Verdigris, OK	1050
	Woodward, OK	440
	Yazoo City, MS	500
<b>Coffeyville Resources Nitrogen Fertilizers, LLC</b>	Coffeyville, KS	413
<b>Dakota Gasification Co.</b>	Beulah, ND	400
<b>Dyno Nobel Inc.</b>	Cheyenne, WY	192
	St. Helens, OR	111
<b>Green Valley Chemical Corp.</b>	Creston, IA	35
<b>Honeywell International Inc.</b>	Hopewell, VA	584
<b>Koch Nitrogen Co., LLC</b>	Beatrice, NE	292
	Dodge City, KS	309
	Enid, OK	1025
	Fort Dodge, IA	386
<b>LSB Industries, Inc.</b>	Cherokee, AL	175
	Pryor, OK	231
<b>Mosaic Co., The</b>	Faustina (Donaldsonville), LA	560
<b>OCI North America</b>	Beaumont, TX	255
<b>PCS Nitrogen, Inc.</b>	Augusta, GA	710
	Geismar, LA	532
	Lima, OH	590
<b>Rentech Energy Midwest Corp.</b>	East Dubuque, IL	306
<b>Total</b>		<b>13,300</b>

## Appendix G: U.S. Nitric Acid Plants

Table 15. U.S. nitric acid producing plants (U.S. EPA, 2009).

Facility name	City	State	No of HNO <sub>3</sub> processes	Abatement technology	Co-location	Monitoring	2006 nameplate capacity (tons HNO <sub>3</sub> 100% acid basis)	Estimated 2006 HNO <sub>3</sub> production (tons HNO <sub>3</sub> )
Agrium US	Beatrice	NE	1	SCR		NOx CEMS	159,835	111,607
Agrium US	Kennewick	WA	1				314,159	219,365
Agrium US	North Bend	OH	1				93,696	65,424
Agrium US	West Sacramento	CA	1				77,162	53,879
Air Products	Pasadena	TX	2	SCR			121,254	84,667
Angus Chemical	Sterlington	LA	1				71,650	50,031
Apache Nitrogen Products	Benson	AZ	2			NOx CEMS	154,324	146,044
CF Industries	Donaldsonville	LA	3	Extended absorption and SCR	ammonia production		749,572	523,399
Dyno Nobel	Battle Mountain	NV	1				275,578	192,426
Dyno Nobel	Cheyenne	WY	3		ammonia production	NOx CEMS	110,231	76,970
Dyno Nobel	St. Helens	OR	1	NSCR	ammonia production		22,046	14,355
Coffeyville Resources	Coffeyville	KS	1	SCR	ammonia production		187,393	130,850
DuPont	Orange	TX	1		adipic production		187,393	130,850
DuPont	Victoria	TX	1		adipic production		330,693	230,911
Dyno Nobel	Donora	PA	1				126,766	88,516
Dyno Nobel	Louisiana	MO	1				297,624	207,820
El Dorado Nitrogen	Baytown	TX	1	SCR		NOx CEMS	490,529	342,519
El Dorado Nitrogen	Cherokee	AL	1		ammonia production		297,624	207,820

<b>El Dorado Nitrogen</b>	El Dorado	AR	5	SCR		NOx CEMS	468,482	327,124
<b>First Chemical</b>	Pascagoula	MS	1			NOx CEMS	82,673	57,728
<b>Geneva Nitrogen</b>	Orem	UT	2	SCR			88,185	81,825
<b>Hercules</b>	Parlin	NJ	1				88,185	61,576
<b>JR Simplot</b>	Helm	CA	1			NOx CEMS	88,185	56,188
<b>JR Simplot</b>	Pocatello	ID	1				22,046	15,394
<b>Koch Nitrogen</b>	Beatrice	NE	1	SCR	ammonia production	NOx CEMS	60,627	42,334
<b>Koch Nitrogen</b>	Dodge City	KS	1		ammonia production		77,162	53,879
<b>Koch Nitrogen</b>	Enid	OK	1	NSCR	ammonia production	NOx CEMS	44,092	30,789
<b>Koch Nitrogen</b>	Fort Dodge	IA	1	SCR	ammonia production	NOx CEMS	181,881	127,002
<b>LSB Industries</b>	Crystal City	MO	1				198,416	138,547
<b>Lyondell Chemical</b>	Lake Charles	LA	1				187,393	130,850
<b>Bayer Corporation</b>	Baytown	TX	1				49,604	34,637
<b>Bayer Corporation</b>	New Martinsville	WV	1				99,208	69,274
<b>Nitrochem</b>	Newell	PA	1				82,673	57,728
<b>Orica</b>	Joplin	MO	1				176,370	123,152
<b>Orica</b>	Morris	IL	1			NOx CEMS	176,370	123,152
<b>PCS Nitrogen</b>	Augusta	GA	2	SCR	ammonia production	NOx CEMS	523,598	365,609
<b>PCS Nitrogen</b>	Geismar	LA	4	SCR	ammonia production	NOx CEMS	909,407	635,006
<b>PCS Nitrogen</b>	Lima	OH	1		ammonia production		115,743	80,819
<b>Rentech Energy Midwest Corporation</b>	East Dubuque	IL	2	Extended absorption and SCR	ammonia production	NOx CEMS	121,254	84,667
<b>Solutia</b>	Pensacola	FL	1	SCR		NOx CEMS	402,344	280,942
<b>Terra International</b>	Port Neal	IA	2	SCR	ammonia production	NOx CEMS	281,089	196,274



<b>Terra International</b>	Verdigris	OK	1		ammonia production	NOx CEMS	694,456	484,913
<b>Terra International</b>	Woodward	OK	1		ammonia production	NOx CEMS	99,208	69,274
<b>Terra International</b>	Yazoo City	MS	4	Extended absorption and SCR	ammonia production	NOx CEMS	1,052,707	677,725
<b>TradeMark Nitrogen</b>	Tampa	FL	1	Extended absorption		NOx CEMS	38,581	26,939
<b>Total</b>	<b>45</b>		<b>65</b>		<b>17</b>	<b>20</b>	<b>10,477,469</b>	<b>7,310,802</b>

## Appendix H: CHP Installations at Fertilizer Plants

Table 16. CHP installations at fertilizer facilities (U.S. EPA, 2016).

Organization Name	Facility Name	City	State	NAICS	Start Year	Capacity (MW)	Prime Mover	Fuel
<b>Missouri Chemical</b>	Hercules, Inc.	Louisiana	MO	325311	1942	15	Steam Turbine	Coal
<b>PCS Nitrogen Fertilizer LP</b>	PCS Nitrogen Fertilizer LP	Millington	TN	325998	1964	25	Gas Turbine	Natural Gas
<b>Mosaic Company</b>	New Wales	Mulberry	FL	325998	1981	80	Steam Turbine	Waste Heat
<b>Mosaic Company</b>	Florida Phosphate Operations	Fort Meade	FL	325312	1983	32	Steam Turbine	Other/Waste Heat
<b>CF Industries</b>	CF Industries	Yazoo City	MS	325311	1984	20	Gas Turbine	Natural Gas
<b>Nitram, Inc.</b>	Nitram, Inc.	Tampa	FL	325998	1985	2	Steam Turbine	Natural Gas
<b>Arcadian Corporation / PCS Nitrogen</b>	Arcadian Ammonia Plant	Geismar	LA	325311	1986	10	Steam Turbine	Natural Gas
<b>Minerals Technologies</b>	Specialty Minerals Inc.	Adams	MA	325998	1988	5	Reciprocating Engine	Natural Gas
<b>Mosaic Company</b>	Plant City Phosphate Complex	Plant City	FL	325312	1989	40	Steam Turbine	Other/Waste Heat
<b>Cogentrix/ Logan Generating Co</b>	Monsanto Plant	Logan Township	NJ	325998	1994	225	Steam Turbine	Coal
<b>Dow Chemical USA</b>	Dow Agro Science	Harbor Beach	MI	325998	1999	7	Gas Turbine	Natural Gas
<b>Rentech Nitrogen</b>	Rentech Nitrogen	Pasadena	TX	325311	2015	15	Steam Turbine	Natural Gas

Table 17. WHP installations at fertilizer facilities (U.S. DOE, 2016).

Organization Name	Facility Name	City	State	NAICS	Start Year	Capacity (MW)	Prime Mover	Fuel
<b>Mosaic Company</b>	Uncle Sam Plant	Uncle Sam	LA	325998	1968	33	Steam Turbine	Waste Heat
<b>Mosaic Company / Agrico Chemical Co</b>	Mosaic Company	Bartow	FL	32532	1977	10	Steam Turbine	Waste Heat
<b>Mosaic Company / Cargill, Inc.</b>	Mosaic Co Martlow Facility	Bartow	FL	325998	1985	82	Steam Turbine	Waste Heat
<b>Simplot Leasing Corporation</b>	Don Plant	Pocatello	ID	325998	1986	16	Steam Turbine	Waste Heat
<b>Mosaic Company / Cargill</b>	Mosaic Co Tampa Facility	Riverview	FL	325998	1988	78	Steam Turbine	Waste Heat
<b>Mosaic Company / IMC Agrico Co</b>	Nichols Operations	Mulberry	FL	325998	1990	13	Steam Turbine	Waste Heat

## Appendix I: Standards for NEMA Motors

The Consortium for Energy Efficiency (CEE) has described the evolution of standards for energy-efficient motors in the United States, which is helpful for understanding “efficient” motor nomenclature (CEE, 2007):

- NEMA Energy Efficient (NEMA EE) was developed in the mid-1980s to define the term “energy efficient” in the marketplace for motors. NEMA Standards Publication No. MG-1 -2011, Table 12-11 defines efficiency levels for a range of different motors (NEMA, 2012).
- The Energy Policy Act of 1992 (EPACT) required that many commonly used motors comply with NEMA “energy efficient” ratings if offered for sale in the United States.
- In 1996, the CEE Premium Efficiency Criteria specification was designed to promote motors with higher efficiency levels than EPACT required, for the same classes of motors covered by EPACT. The CEE efficiency levels specified were generally two NEMA efficiency bands (Table 12-10, NEMA MG-1-2011) above those required by EPACT.

In 2001, the NEMA Premium Efficiency Electric Motor specification was developed to address confusion with respect to what constituted the most efficient motors available in the market. This specification was developed by NEMA, CEE, and other stakeholders, and was adapted from the CEE 1996 criteria. It currently serves as the benchmark for premium energy efficient motors. NEMA Premium® also denotes a brand name for motors, which meet this specification. Specifically, this specification covers motors with the following attributes:

- Speed: 2, 4, and 6 pole.
- Size: 1-500 horsepower (hp).
- Design: NEMA A and B.
- Enclosure type: open and closed.
- Voltage: low and medium voltage.
- Class: general, definite, and special purpose.

## Appendix J: Energy Management Program Assessment Matrix



### Introduction

The U.S. EPA has developed guidelines for establishing and conducting an effective energy management program based on the successful practices of ENERGY STAR partners.

These guidelines, illustrated in the graphic, are structured on seven fundamental management elements that encompass specific activities.

This assessment matrix is designed to help organizations and energy managers compare their energy management practices to those outlined in the Guidelines. The full Guidelines can be viewed on the ENERGY STAR web site – <http://www.energystar.gov/guidelines>.

### How To Use The Assessment Matrix

The matrix outlines the key activities identified in the ENERGY STAR Guidelines for Energy Management and three levels of implementation:

- No evidence.
- Most elements.
- Fully Implemented.

1. Print the assessment matrix.
2. Compare your program to the Guidelines by identifying the degree of implementation that most closely matches your organization's program.
3. Use a highlighter to fill in the cell that best characterizes the level of implementation of your program. You will now have a visual comparison of your program to the elements of the ENERGY STAR Guidelines for Energy Management.

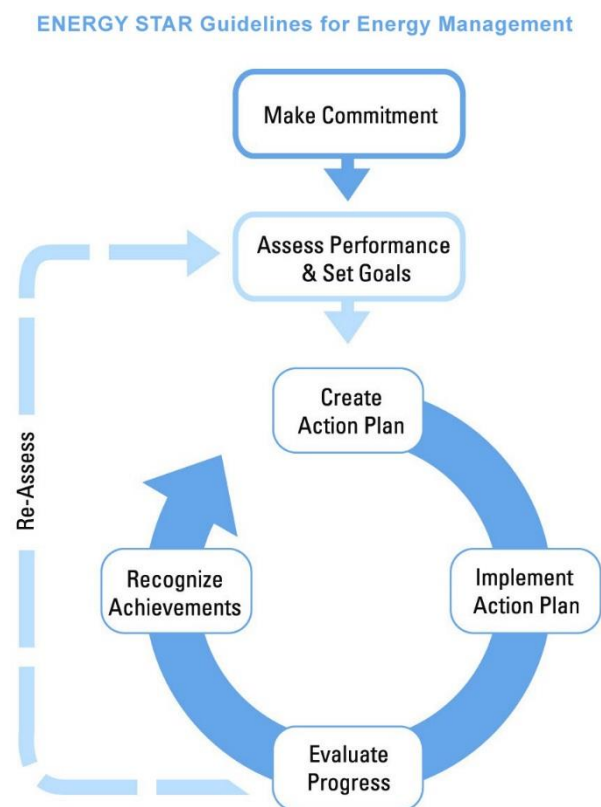

- Identify the steps needed to fully implement the energy management elements and record these in the Next Steps column.

<b>Energy Management Program Assessment Matrix</b>				
	Little or no evidence	Some elements	Fully implemented	Next Steps
<b>Make Commitment to Continuous Improvement</b>				
Energy Director	No central corporate resource Decentralized management	Corporate or organizational resource not empowered	Empowered corporate leader with senior management support	
Energy Team	No company energy network	Informal organization	Active cross-functional team guiding energy program	
Energy Policy	No formal policy	Referenced in environmental or other policies	Formal stand-alone EE policy endorsed by senior mgmt.	
<b>Assess Performance and Opportunities</b>				
Gather and Track Data	Little metering/no tracking	Local or partial metering/tracking/reporting	All facilities report for central consolidation/analysis	
Normalize	Not addressed	Some unit measures or weather adjustments	All meaningful adjustments for corporate analysis	
Establish baselines	No baselines	Various facility-established	Standardized corporate base year and metric established	
Benchmark	Not addressed or only same site historical comparisons	Some internal comparisons among company sites	Regular internal & external comparisons & analyses	
Analyze	Not addressed	Some attempt to identify and correct spikes	Profiles identifying trends, peaks, valleys & causes	
Technical assessments and audits	Not addressed	Internal facility reviews	Reviews by multi-functional team of professionals	
<b>Set Performance Goals</b>				
Determine scope	No quantifiable goals	Short term facility goals or nominal corporate goals	Short & long term facility and corporate goals	
Estimate potential for improvement	No process in place	Specific projects based on limited vendor projections	Facility & corporate defined based on experience	
Establish goals	Not addressed	Loosely defined or sporadically applied	Specific & quantifiable at various organizational levels	
<b>Create Action Plan</b>				

<b>Energy Management Program Assessment Matrix</b>				
	Little or no evidence	Some elements	Fully implemented	Next Steps
Define technical steps and targets	Not addressed	Facility-level consideration as opportunities occur	Detailed multi-level targets with timelines to close gaps	
Determine roles and resources	Not addressed or done on ad hoc basis	Informal interested person competes for funding	Internal/external roles defined & funding identified	
<b>Implement Action Plan</b>				
Create a communication plan	Not addressed	Tools targeted for some groups used occasionally	All stakeholders are addressed on regular basis	
Raise awareness	No promotion of energy efficiency	Periodic references to energy initiatives	All levels of organization support energy goals	
Build capacity	Indirect training only	Some training for key individuals	Broad training/certification in technology & best practices	
Motivate	No or occasional contact with energy users and staff	Threats for non-performance or periodic reminders	Recognition, financial & performance incentives	
Track and monitor	No system for monitoring progress	Annual reviews by facilities	Regular reviews & updates of centralized system	
<b>Evaluate Progress</b>				
Measure results	No reviews	Historical comparisons	Compare usage & costs vs. goals, plans, competitors	
Review action plan	No reviews	Informal check on progress	Revise plan based on results, feedback & business factors	
<b>Recognize Achievements</b>				
Provide internal recognition	Not addressed	Identify successful projects	Acknowledge contributions of individuals, teams, facilities	
Get external recognition	Not sought	Incidental or vendor acknowledgement	Government/third party highlighting achievements	

## Interpreting Your Results

Comparing your program to the level of implementation identified in the Matrix should help you identify the strengths and weaknesses of your program.

The U.S. EPA has observed that organizations fully implementing the practices outlined in the Guidelines achieve three greatest results. Organizations are encouraged to implement the Guidelines as fully as possible.

By highlighting the cells of the matrix, you now can easily tell how well balanced your energy program is across the management elements of the Guidelines. Use this illustration of your energy management program for discussion with staff and management.

Use the "Next Steps" column of the Matrix to develop a plan of action for improving your energy management practices.

## Resources and Help

ENERGY STAR offers a variety tools and resources to help organizations strengthen their energy management programs.

Here are some next steps you can take with ENERGY STAR:

1. Read the Guidelines sections for the areas of your program that are not fully implemented.
2. Review ENERGY STAR Tools and Resources.
3. Find more sector-specific energy management information at <http://www.energystar.gov/industry>
4. Become an ENERGY STAR Partner, if your company is not already, to take advantage of additional resources.



## Appendix K: Teaming Up to Save Energy Checklist

The following checklist can be used as a handy reference to key tasks for establishing and sustaining an effective energy team. For more detailed information on energy teams, consult the U.S. EPA's *Teaming Up to Save Energy* guide (U.S. EPA, 2006), which is available at <http://www.energystar.gov/energyteam>.

<b>ORGANIZE YOUR ENERGY TEAM</b>		√
Energy Director	Able to work with all staff levels from maintenance to engineers to financial officers. Senior-level person empowered by top management support	
Senior Management	Energy director reports to senior executive or to a senior management council. Senior champion or council provides guidance and support	
Energy Team	Members from business units, operations/engineering, facilities, and regions. Energy networks formed. Support services (PR, IT, HR).	
Facility Involvement	Facility managers, electrical personnel. Two-way information flow on goals and opportunities. Facility-based energy teams with technical person as site champion.	
Partner Involvement	Consultants, vendors, customers, and joint venture partners. Energy savings passed on through lower prices.	
Energy Team Structure	Separate division and/or centralized leadership. Integrated into organization's structure and networks established.	
Resources & Responsibilities	Energy projects incorporated into normal budget cycle as line item. Energy director is empowered to make decisions on projects affecting energy use. Energy team members have dedicated time for the energy program.	
<b>STARTING YOUR ENERGY TEAM</b>		√
Management Briefing	Senior management briefed on benefits, proposed approach, and potential energy team members.	
Planning	Energy team met initially to prepare for official launch.	
Strategy	Energy team met initially to prepare for official launch.	
Program Launch	Organizational kickoff announced energy network, introduced energy director, unveiled energy policy, and showcased real-world proof.	
Energy Team Plans	Work plans, responsibilities, and annual action plan established.	
Facility Engagement	Facility audits and reports conducted. Energy efficiency opportunities identified.	

<b>BUILDING CAPACITY</b>		√
Tracking and Monitoring	Systems established for tracking energy performance and best practices implementation.	
Transferring Knowledge	Events for informal knowledge transfer, such as energy summits and energy fairs, implemented.	
Raising Awareness	Awareness of energy efficiency created through posters, intranet, surveys, and competitions.	
Formal Training	Participants identified, needs determined, training held. Involvement in ENERGY STAR Web conferences and meetings encouraged. Professional development objectives for key team members.	
Outsourcing	Use of outside help has been evaluated and policies established.	
Cross-Company Networking	Outside company successes sought and internal successes shared. Information exchanged to learn from experiences of others.	
<b>SUSTAINING THE TEAM</b>		√
Effective Communications	Awareness of energy efficiency created throughout company. Energy performance information is published in company reports and communications.	
Recognition and Rewards	Internal awards created and implemented. Senior management is involved in providing recognition.	
External Recognition	Credibility for your organization's energy program achieved. Awards from other organizations have added to your company's competitive advantage.	
<b>MAINTAINING MOMENTUM</b>		√
Succession	Built-in plan for continuity established. Energy efficiency integrated into organizational culture.	
Measures of Success	Sustainability of program and personnel achieved. Continuous improvement of your organization's energy performance attained.	

## Appendix L: Support Programs for Industrial Energy Efficiency Improvement

This appendix provides a list of energy efficiency support available to industry. A brief description of the program or tool is given, as well as information on its target audience and the URL for the program. Included are federal and state programs. Use the URL to obtain more information from each of these sources. An attempt was made to provide as complete a list as possible; however, information in this listing may change with the passage of time.

### Tools for Self-Assessment

#### Steam System Assessment Tool

Description: Software package to evaluate energy efficiency improvement projects for steam systems. It includes an economic analysis capability.

Target Group: Any industry operating a steam system

Format: Downloadable software package (13.6 MB)

Contact: U.S. Department of Energy

URL: <http://energy.gov/eere/amo/software-tools>.

#### Steam System Scoping Tool

Description: Spreadsheet tool for plant managers to identify energy efficiency opportunities in industrial steam systems.

Target Group: Any industrial steam system operator

Format: Downloadable software (Excel)

Contact: U.S. Department of Energy

URL: <http://energy.gov/eere/amo/software-tools>.

#### MotorMaster+

Description: Energy efficient motor selection and management tool, including a catalog of over 20,000 AC motors. It contains motor inventory management tools, maintenance log tracking, efficiency analysis, savings evaluation, energy accounting, and environmental reporting capabilities.

Target Group: Any industry

Format: Downloadable software (can also be ordered on CD)

Contact: U.S. Department of Energy

URL: <http://energy.gov/eere/amo/motor-systems> .

#### The 1-2-3 Approach to Motor Management

Description: A step-by-step motor management guide and spreadsheet tool that can help motor service centers, vendors, utilities, energy-efficiency organizations, and others convey the financial benefits of sound motor management.

Target Group: Any industry

Format: Downloadable Microsoft Excel spreadsheet

Contact: Consortium for Energy Efficiency (CEE), (617) 589-3949

URL: <http://www.motorsmatter.org/tools/123approach.html>.

**AirMaster+: Compressed Air System Assessment and Analysis Software**

Description: Modeling tool that maximizes the efficiency and performance of compressed air systems through improved operations and maintenance practices.

Target Group: Any industry operating a compressed air system

Format: Downloadable software

Contact: U.S. Department of Energy

URL: <http://energy.gov/eere/amo/software-tools>.

**Fan System Assessment Tool (FSAT)**

Description: The Fan System Assessment Tool (FSAT) helps to quantify the potential benefits of optimizing a fan system. FSAT calculates the amount of energy used by a fan system, determines system efficiency, and quantifies the savings potential of an upgraded system.

Target Group: Any user of fans

Format: Downloadable software

Contact: U.S. Department of Energy

URL: <http://energy.gov/eere/amo/software-tools>.

**Pumping System Assessment Tool (PSAT)**

Description: The tool helps industrial users assess the efficiency of pumping system operations. PSAT uses achievable pump performance data from Hydraulic Institute standards and motor performance data from the MotorMaster+ database to calculate potential energy and associated cost savings.

Target Group: Any industrial pump user

Format: Downloadable software

Contact: U.S. Department of Energy

URL: <http://energy.gov/eere/amo/software-tools>.

**Plant Energy Profiler/Integrated Tool Suite**

Description: The Plant Energy Profiler, or ePEP (formerly called Quick PEP), is an online software tool provided by the U.S. Department of Energy to help industrial plant managers in the United States identify how energy is being purchased and consumed at their plant and also identify potential energy and cost savings. ePEP is designed so that the user can complete a plant profile in about an hour. The ePEP online tutorial explains what plant information is needed to complete an ePEP case.

Target Group: Any industrial plant

Format: Online software tool

Contact: U.S. Department of Energy

URL: <http://energy.gov/eere/amo/software-tools>

**ENERGY STAR Portfolio Manager**

Description: Online software tool helps to assess the energy performance of buildings by providing a 1-100 ranking of a building's energy performance relative to the national building market. Measured energy consumption forms the basis of the ranking of performance.

Target Group: Any building user or owner

Format: Online software tool

Contact: U.S. Environmental Protection Agency

URL: <http://www.energystar.gov/buildings/facility-owners-and-managers/existing-buildings/use-portfolio-manager>.

**ENERGY STAR Energy Tracking Tool**

Description: Provides manufacturers with a simple means for tracking their energy performance over time and progress toward goals. This Microsoft Excel-based tool enables users to define custom energy intensity metrics, and select from a variety of reports.

Target Group: Any manufacturing plant user or owner

Format: Microsoft Excel-based tool

Contact: U.S. Environmental Protection Agency

URL: <http://www.energystar.gov/ett>.

**Assessment and Technical Assistance****Industrial Assessment Centers**

Description: Small- to medium-sized manufacturing facilities can obtain a free energy and waste assessment. The audit is performed by a team of engineering faculty and students from 30 participating universities in the U.S. and assesses the plant's performance and recommends ways to improve efficiency.

Target Group: Small- to medium-sized manufacturing facilities with gross annual sales below \$75 million and fewer than 500 employees at the plant site.

Format: A team of engineering faculty and students visits the plant and prepares a written report with energy efficiency, waste reduction, and productivity recommendations.

Contact: U.S. Department of Energy

URL: <http://energy.gov/eere/amo/industrial-assessment-centers-iacs>.

**Manufacturing Extension Partnership (MEP)**

Description: MEP is a nationwide network of not-for-profit centers in over 400 locations providing small- and medium-sized manufacturers with technical assistance. A center provides expertise and services tailored to the plant, including a focus on clean production and energy-efficient technology.

Target Group: Small- and medium-sized plants

Format: Direct contact with local MEP Office

Contact: National Institute of Standards and Technology, (301) 975-5020

URL: <http://www.nist.gov/mep/>.

**Small Business Development Center (SBDC)**

Description: The U.S. Small Business Administration (SBA) administers the Small Business Development Center Program to provide management assistance to small businesses through 58 local centers. The SBDC Program provides counseling, training, and technical assistance in the areas of financial, marketing, production, organization, engineering and technical problems and feasibility studies, if a small business cannot afford consultants.

Target Group: Small businesses

Format: Direct contact with local SBDC

Contact: Small Business Administration, (800) 8-ASK-SBA

URL: <http://www.sba.gov/sbdc/>.

**ENERGY STAR – Selection and Procurement of Energy-Efficient Products for Business**

Description: ENERGY STAR identifies and labels energy-efficient office equipment. Look for products that have earned the ENERGY STAR. They meet strict energy efficiency guidelines set by the EPA. Office equipment included such items as computers, copiers, faxes, monitors, multifunction devices, printers, scanners, transformers, and water coolers.

Target Group: Any user of labeled equipment.

Format: Website

Contact: U.S. Environmental Protection Agency

URL: <http://www.energystar.gov/products?s=mega>.

## Federal, State, Local, and Utility Incentives

Government and utilities sponsor incentives to assist businesses in assessing or financing energy-efficient process technology or buildings. Please contact your utility, state, and local government to determine what tax benefits, funding grants, or other assistance they may be able to provide your organization.

### **Database of State Incentives for Renewables & Efficiency (DSIRE)**

Description: DSIRE is a comprehensive source of information on state, local, utility, and federal incentives and policies that promote renewable energy and energy efficiency. Established in 1995, DSIRE is an ongoing project of the NC Solar Center and the Interstate Renewable Energy Council funded by the U.S. Department of Energy.

Target Group: Any industry

URL: <http://www.dsireusa.org/>.

## Glossary

AC	Alternating Current
a-MDEA	Activated diethanolamine
AN	Ammonium nitrate
ANS	Ammonium nitrate solution
AS	Ammonium sulfate
ASDs	Adjustable speed drives
atm	Atmosphere
BAT	Best Available Technologies
BPT	Best Practice Technologies
BBBP	Better Buildings Better Plants
Btu	British thermal unit
CAC	Compressed Air Challenge®
CADDET	Centre for the Analysis and Dissemination of Demonstrated Technologies
CAN	Calcium ammonium nitrate
CDA	Copper Development Association
CEE	Consortium of Energy Efficiency
(CH <sub>2</sub> ) <sub>5</sub> CNH	Caprolactam
CH <sub>4</sub>	Methane
CHP	Combined Heat and Power
CDM	Clean Development Mechanism
CFD	Computational Fluid Dynamics
CFL	Compact fluorescent lamp
cfm	Cubic feet per minute
CIM	Computer Integrated Manufacturing
CIPEC	Canadian Industry Program for Energy Conservation
cm	Centimeter
CN	Calcium nitrate
CO	Carbon monoxide
CO <sub>2</sub>	Carbon dioxide
CO <sub>3</sub> O <sub>4</sub>	Cobalt oxide
Cu	Copper
ΔH	Enthalpy change
EASA	Electric Apparatus Service Association
EFMA	European Fertilizer Manufacturers Association
EIA	Energy Information Administration (U.S. Department of Energy)
EPACT	Energy Policy Act
GHGs	Greenhouse gases
GJ	Gigajoule
GSA	Geometric Surface Area
GWP	Global Warming Potential
H <sub>2</sub>	Hydrogen
H <sub>2</sub> O	Water
HHV	High Heating Value
HID	High Intensity-discharge

HNO <sub>3</sub>	Nitric acid
HP	High pressure
hp	Horsepower
HPCC	High pressure carbamate condenser
HTC	Heat Transfer Coefficient
HTER	Haldor Topsoe Exchange Reformer
HTS	High Temperature Shift
HVAC	Heating, ventilation, and air-conditioning
Hz	Hertz
IAC	Industrial Assessment Center
IDR	Isobaric Double Recycling
IEA	International Energy Agency
IFA	International Fertilizer Industry Association
IPCC	Intergovernmental Panel on Climate Change
ISO	International Organization for Standardization
KAAP	Kellogg Advance Ammonia Process
KBS	Knowledge Based Systems
kBtu	Thousand British Thermal Unit
kcal	Kilocalorie
kg	Kilogram
kJ	Kilojoule
kmol	Kilomol
KRES	Kellogg Reforming Exchanger System
kW	Kilowatt
kWh	Kilowatt-hour
LAC	Linde Ammonia Concept
LBNL	Lawrence Berkeley National Laboratory
LCC	Life Cycle Costing
LED	Light-emitting diode
LHV	Low Heating Value
Low-E	Low-emittance
LP	Low pressure
LRC	Lighting Research Center
LTS	Low Temperature Shift
MMBtu	Million British Thermal Units
MDM	Motor Decisions Matter <sup>SM</sup>
MDEA	Diethanolamine
MEA	Monoethanolamine
MECS	Manufacturing Energy Consumption Survey
mm	Millimeter
mol	Mole
MPa	Megapascal
Mton	Million tons
MW	Million Watt (megawatt)
MWh	Millionwatt-hour (megawatt-hour)
NAICS	North American Industry Classification System
NEMA	National Electrical Manufacturers Association
NEMA EE	National Electrical Manufacturers Association Energy Efficiency



N	Nitrogen
Nb	Niobium
N <sub>2</sub> O	Nitrous oxide
NA	Nitric acid
NH <sub>2</sub> CO <sub>2</sub> NH <sub>4</sub>	Ammonium carbamate
NH <sub>3</sub>	Ammonia
NH <sub>4</sub>	Ammonium
NH <sub>4</sub> NO <sub>3</sub>	Ammonium nitrate
(NH <sub>4</sub> ) <sub>2</sub> SO <sub>4</sub>	Ammonium sulfate
NO <sub>3</sub>	Nitrate
NO <sub>x</sub>	Nitrogen oxides
NSCR	Non-selective catalytic reduction
PD	Pressure drop
pH	Potential of Hydrogen
PJ	Petajoule
ppm	Parts per million
PSA	Pressure Swing Absorption
psi	Pound per square inch
psid	Pound per square inch (differential)
psig	Pound per square inch (gauge)
Pd	Palladium
Pt	Platinum
Rh	Rhodium
SCR	Selective Catalytic Reduction
SHP	Separate heat and power
SO <sub>2</sub>	Sulfur dioxide
TBtu	Trillion British thermal unit
Ti	Titanium
TJ	Terajoule
tpd	Tons per day
UAN	Urea-ammonium nitrate
UK	United Kingdom
UNEP	United Nations Environment Programme
U.S. DOE	United States Department of Energy
U.S. EPA	United States Environmental Protection Agency
USGS	United States Geological Survey
VFDs	Variable frequency drives
VSDs	Variable speed drives
W	Watt
WBCSD	World Business Council on Sustainable Development
WHP	Waste heat to power
Zn	Zinc
Zr	Zirconium

## References

- Abrardo, J.M. and V. Khuruna (1995). Hydrogen Technologies to Meet Refiners' Future Needs. *Hydrocarbon Processing* 2 74, pp.43-49 (February 1995).
- Alesson, T. (1995). All Steam Traps Are Not Equal. *Hydrocarbon Processing* 74.
- Assessment to Action (A2A) Toolkit. Institute for Industrial Productivity (IIP) and ICF Marbek <http://www.iipnetwork.org/a2a>
- Australian Government (2009). Energy efficiency opportunities – Case study Incitec Pivot Gibson Island. Australian Government, Department of Resources, Energy and Tourism, April 2009 <http://www.ret.gov.au/energy/documents/energyefficiencyopps/pdf/industry%20case%20study%20incitec%20pivot.pdf>
- Awasthi (unknown date). U.S. / IICHE. Challenges & Innovations in technology of ammonia urea plants. Indian Farmers Fertiliser Cooperative Ltd. First Foundation Day of Indian Institute of Chemical Engineers. [http://www.iffco.nic.in/applications/brihaspat.nsf/0/3e4107b1a83752476525726b00418c30/\\$FILE/IICHEPresentation.pdf](http://www.iffco.nic.in/applications/brihaspat.nsf/0/3e4107b1a83752476525726b00418c30/$FILE/IICHEPresentation.pdf)
- Baen, P.R. and R.E. Barth (1994). Insulate heat tracing systems correctly. *Chemical Engineering Progress*, September 1994, pp. 41-46.
- Barnish, T. J., M. R. Muller, and D. J. Kasten, (1997). Motor Maintenance: A Survey of Techniques and Results. Proceedings of the 1997 ACEEE Summer Study on Energy Efficiency in Industry. American Council for an Energy-Efficient Economy, Washington, D.C.
- BASF (2012). BASF: The right choice for nitric acid plants. <https://www.basf.com/en.html>
- Bayne, C. (2011). Titan America. Personal Communication.
- Bernstein, L., J. Roy, K. C. Delhotal, J. Harnisch, R. Matsushashi, L. Price, K. Tanaka, E. Worrell, F. Yamba, and Z. Fengqi, (2007): Industry. In *Climate Change 2007: Mitigation. Contribution of Working Group III to the Fourth Assessment Report of the Intergovernmental Panel on Climate Change* [B. Metz, O.R. Davidson, P.R. Bosch, R. Dave, L.A. Meyer (eds)], Cambridge University Press, Cambridge, United Kingdom and New York, NY, USA.
- Best Practice Programme (1996). Good Practice Case Study 300: Energy Savings by Reducing the Size of a Pump Impeller. Available for download at <http://www.carbontrust.co.uk/default.htm>
- Best Practice Programme (1998). Good Practice Guide 249: Energy Savings in Industrial Water Pumping Systems. Available for download at <http://www.carbontrust.co.uk/default.htm>
- Bloss, D., R. Bockwinkel, and N. Rivers (1997). Capturing Energy Savings with Steam Traps. Proc. 1997 ACEEE Summer Study on Energy Efficiency in Industry, ACEEE, Washington DC, USA.

Beyer, F., J. Brightling, P. Farnell, C. Foster (2005). Steam Reforming – 50 Years of Development and the challenges for the Next 50 Years. Prepared for presentation at AIChE 50<sup>th</sup> Annual Safety in Ammonia Plants and Related Facilities Symposium, Toronto, September 26-20 , 2005, Canada. [http://www.uhde-ftp.de/cgi-bin/byteserver.pl/archive/upload/uhde\\_publications\\_pdf\\_en\\_53.00.pdf](http://www.uhde-ftp.de/cgi-bin/byteserver.pl/archive/upload/uhde_publications_pdf_en_53.00.pdf)

Caffal, C. (1995). "Energy Management in Industry," *CADDET Analyses Series 17*, Sittard, the Netherlands: CADDET.

Canadian Industry Program for Energy Conservation (CIPEC) 2001. Boilers and Heaters, Improving Energy-efficiency. Natural Resources Canada, Office of Energy-efficiency, Ottawa, Ontario, Canada.

Catalyst Development Corporation (CDC) (2003). Cobalt oxide catalyst. <http://www.cobaltoxide.com/index.html>

CEAMAG (2009) [http://www.ceamag.com/index.php?option=com\\_content&view=article&id=31&Itemid=44&lang=en](http://www.ceamag.com/index.php?option=com_content&view=article&id=31&Itemid=44&lang=en)

Centre for the Analysis and Dissemination of Demonstrated Energy Technologies (CADDET) (1997a). Keeping a Steam Boiler on Hot Standby (Project NL-1990-044).

Centre for the Analysis and Dissemination of Demonstrated Energy Technologies (CADDET) (1997b). Saving Energy with Efficient Compressed Air Systems. Maxi Brochure 06.

Centre for the Analysis and Dissemination of Demonstrated Energy Technologies (CADDET) (2001a). Saving Energy with Daylighting Systems. Centre for the Analysis and Dissemination of Demonstrated Energy Technologies (CADDET). Maxi Brochure 14, Sittard, the Netherlands.

Centre for the Analysis and Dissemination of Demonstrated Energy Technologies (CADDET) (2001b). Saving energy with Steam Production and Distribution. Centre for the Analysis and Dissemination of Demonstrated Energy Technologies. Maxi Brochure 13, Sittard, The Netherlands. Available at: [www.caddet.org](http://www.caddet.org).

Clean Development Mechanism (CDM) (2004). Reduction in steam consumption through revamping of ammonia plant of Indian Farmers Fertilizer Cooperative Ltd. (IFFCO) plants <https://cdm.unfccc.int/filestorage/Y/6/A/Y6AY12VBKHEPDXICMGNFXPQJCGIV1M/PDD.pdf?t=MVV8bWx0ZGd6fDC42HhIKijjL4D9sI8XkXfj>

Clean Development Mechanism (CDM) (2006). Catalytic N<sub>2</sub>O destruction in the tail gas of three nitric acid plants at Hu-Chems Fine Chemical Corp. <https://cdm.unfccc.int/Projects/DB/TUEV-SUED1163081212.47/view>

Christensen, P.V. (2001a). Design and operation of large capacity ammonia plants. 4<sup>th</sup> conference for development and integration of Petrochemical Industries in the Arab States. Bahrain, May 7-8.

Christensen, P.V. (2001b). Revamping ammonia plants to follow feedstock situation and market demands. Presentation at the FAI symposium on improving productivity of ammonia and urea plants, New Delhi, India, April 19-20.

Consortium for Energy Efficiency (CEE) 2007. Energy-Efficiency Incentive Programs: Premium-Efficiency Motor & Adjustable Speed Drives in the U.S. and Canada. Boston, Massachusetts. May.

Cook, B. (1998). High-efficiency lighting in Industry and Commercial Buildings. Power Engineering Journal. October: 197-206.

Copper Development Association (CDA) (2001). High-Efficiency Copper-Wound Motors Mean Energy and Dollar Savings. New York, New York.

Council of Industrial Boiler Owners (CIBO) (1998). Personal Communication

CRI (2010a). CRI N<sub>2</sub>O abatement technology. <http://www.cricatalyst.com/content/dam/shell/static/cricatalyst/downloads/business/s-097-high-res.pdf>

CRI (2010b). CRI N<sub>2</sub>O decomposition. [http://www.environmentalcatalysts.com/N2O\\_Decomposition.htm](http://www.environmentalcatalysts.com/N2O_Decomposition.htm)

CREST 2001. Center for Renewable Energy and Sustainable Technology ,Solar Thermal Catalog—Chapter 5.2: Ford Motor Company/ Chicago Stamping Plant.

Durilla, M. (2009). NO<sub>x</sub> and N<sub>2</sub>O Control in Nitric Acid Plants. Environment Management. Air and Waste Management Association. November 2009

Ecofys (2013). Work in progress on Energy intensity and best practice in ammonia production. Utrecht, The Netherlands.

Efficiency Partnership (2004). Industrial Product Guide – Manufacturing and Processing Equipment: Compressed Air Equipment. Flex Your Power, San Francisco, California.

Electric Apparatus Service Association (EASA) (2003). The Effect of Repair/Rewinding on Motor Efficiency. St. Louis, Missouri.

Electric Apparatus Service Association (EASA) (2006). ANSI/EASA Standard AR100-2006. Recommended Practice for the Repair of Rotating Electrical Apparatus. St. Louis, Missouri.

Eley, C., T.M. Tolen, J.R. Benya, F. Rubinstein and R. Verderber (1993). Advanced Lighting Guidelines: 1993. California Energy Commission, Sacramento, California, USA.

Elliott, R.N., 1994. Electricity Consumption and the Potential for Electric Energy Savings in the Manufacturing Sector. American Council for an Energy-Efficient Economy, Washington, D.C. Report IE942.

Energy Information Administration, U.S. Department of Energy (EIA) (2013). Manufacturing Energy Consumption Survey, 2010. Washington, DC.

Erben, A. (2009). Ways to improve the energy efficiency of AN solution plants. Prepared for presentation at Nitrogen 2009 International Conference, 22-25 February, 2009, Rome, Italy.

European Fertilizer Manufacturers Association (EFMA) (2000a). Best Available Techniques for Pollution Prevention and Control in the European Fertilizer Industry, Booklet No. 1 of 8: Production of Ammonia. Brussels, Belgium.

European Fertilizer Manufacturers Association (EFMA) (2000b). Best Available Techniques for Pollution Prevention and Control in the European Fertilizer Industry, Booklet No. 2 of 8: Production of Nitric Acid. Brussels, Belgium.

European Fertilizer Manufacturers Association (EFMA) (2000c). Best Available Techniques for Pollution Prevention and Control in the European Fertilizer Industry, Booklet No. 5 of 8: Production of Urea and Urea Ammonium Nitrate. Brussels, Belgium.

European Fertilizer Manufacturers Association (EFMA) (2000d). Best Available Techniques for Pollution Prevention and Control in the European Fertilizer Industry, Booklet No. 6 of 8: Production of Ammonium Nitrate and Calcium Ammonium Nitrate. Brussels, Belgium.

Fenning, L. et al. (Eds.) (2001). Pump Life Cycle Costs: A Guide to LCC Analysis for Pumping Systems. Hydraulic Institute/Europump/ United States Department of Energy. ISBN: 1-880952-58-0.

The Fertilizer Association India (FAI) (2013). Report on Industrial Energy Technology Database (IETD) and Energy Efficiency best practices with reference to Indian Ammonia Industry. Final Draft Report.

Food and Agriculture Organization of the United Nations (FAO) (2000). Fertilizers and their Use. 4<sup>th</sup> edition. Rome, Italy.

Forster, P., V. Ramaswamy, P. Artaxo, T. Berntsen, R. Betts, D.W. Fahey, J. Haywood, J. Lean, D.C. Lowe, G. Myhre, J. Nganga, R. Prinn, G. Raga, M. Schulz and R. van Dorland. (2007). Changes in Atmospheric Constituents and in Radiative Forcing. In: Climate Change 2007: The Physical Science Basis. Contribution of Working Group I to the Fourth Assessment Report of the Intergovernmental Panel on Climate Change [Solomon, S., D. Qin, M. Manning, Z. Chen, M. Marquis, K.B. Averyt, M. Tignor and H.L. Miller (eds.)]. Cambridge University Press, Cambridge, United Kingdom and New York, NY, USA.

Galindo, F. and Córton, S. (1998). Energy optimization of a high mono-pressure nitric acid plant. IFA technical conference papers, 28 Sept.–1 Oct. 1998. Marrakech, Morocco.

Galitsky, C., S.C. Chang, E. Worrell, and E. Masanet (2005). Energy Efficiency Improvement and Cost Saving Opportunities for the Pharmaceutical Industry: An ENERGY STAR Guide for Energy and Plant Managers. Lawrence Berkeley National Laboratory, Berkeley, California. Report LBNL- 57260.

Galle M., D.W. Agar, and O. Watzenberger (2001). Thermal N<sub>2</sub>O decomposition in regenerative heat exchanger reactors. *Chemical Engineering Science* 56 (2001) pp. 1587-1595.

Groves, M., R. Maurer, M. Schwefer, and R. Siefert (2006a). Abatement of N<sub>2</sub>O and NO<sub>x</sub> emissions from nitric acid plants with the Uhde EnviNOx<sup>®</sup> process – Design, operating experience and current developments. Dortmund, Germany.

Groves, M., R. Maurer, M. Schwefer, and R. Siefert (2006b). Nitric acid – without the emissions. Dortmund, Germany. <http://www.thyssenkrupp-industrial-solutions.com/en/products-solutions/chemical-industry/nitrates/nitric-acid/information/nitric-acid-without-the-emissions.html>

Groves, M. and Sasonow, A. (2009). Uhde EnviNO<sub>x</sub>® technology for NO<sub>x</sub> and N<sub>2</sub>O abatement – A contribution to reducing emissions from nitric acid plants. 5<sup>th</sup> International Symposium on non-CO<sub>2</sub> Greenhouse Gases, June 30 – July 3, 2009. Wageningen, the Netherlands.

Haldor Topsoe (2007). Latest developments in ammonia production technology. Presentation by Svend Erik Nielsen at the FAI International Conference in Fertilizer Technology, 12-13 April 2007, New Delhi, India.

Haldor Topsoe (2011a). HTER – Haldor Topsoe Exchange Reformer.

Haldor Topsoe (2011b). RKS-2-7H secondary reforming catalyst. [http://www.topsoe.com/business\\_areas/ammonia/~media/PDF%20files/Steam\\_reforming/Secondary\\_reforming\\_catalyst\\_RKS%20%207H.ashx](http://www.topsoe.com/business_areas/ammonia/~media/PDF%20files/Steam_reforming/Secondary_reforming_catalyst_RKS%20%207H.ashx)

Haldor Topsoe (2012). Topsoe ammonia technology. [http://www.topsoe.com/business\\_areas/ammonia/~media/PDF%20files/Ammonia/topsoe\\_ammonia\\_technology.ashx](http://www.topsoe.com/business_areas/ammonia/~media/PDF%20files/Ammonia/topsoe_ammonia_technology.ashx)

Hallale, N. (2001). Burning Bright: Trends in Process Integration. Chemical Engineering Progress 7 97 pp.30-41 (July 2001).

Heraeus (2006). Heraeus nitro technologies. Hanau, Germany.

Hodgson, J. and T. Walters (2002). Optimizing Pumping Systems to Minimize First or Life-Cycle Costs. Proc. 19th International Pump Users Symposium, Houston, Texas, USA, February 25th-28th, 2002.

Honeywell (unknown date). Advanced process control implementation in ammonia plant.

Honeywell (2012). BASF Ammonia plant increases production and achieves ROI in six months with profit controller. Website Honeywell, accessed 21 February 2013.

[http://hpsregional.honeywell.com/HPSWebII/UI/Templates/TwoColumn.aspx?NRMODE=Published&NRNODEGUID=%7BA70DDC2C-58FE-4095-A527-DA3F79964402%7D&NRORIGINALURL=%2FCultures%2Fen-US%2FNewsEvents%2FSuccessStories%2FSuccess\\_BASF\\_APC.htm&NRCACHEHINT=Guest](http://hpsregional.honeywell.com/HPSWebII/UI/Templates/TwoColumn.aspx?NRMODE=Published&NRNODEGUID=%7BA70DDC2C-58FE-4095-A527-DA3F79964402%7D&NRORIGINALURL=%2FCultures%2Fen-US%2FNewsEvents%2FSuccessStories%2FSuccess_BASF_APC.htm&NRCACHEHINT=Guest)

Hovstadius, G. (2007). Key Performance Indicators for Pumping Systems. Proceedings EEMODS '07 Conference, Beijing, China, June 10-13, 2007.

Howe, B. and B. Scales (1995). "Assessing Processes for Compressed Air Efficiency," *E-Source Tech Update*. November 1995.

Huang, W. (2007). Impact of Rising Natural Gas Prices on U.S. Ammonia Supply. United States Department of Agriculture (USDA)/Economic Research Service (ERS). WRS-0702.

Hydraulic Institute and Europump (2001). Pump Life Cycle Costs: A Guide to LCC Analysis for Pumping Systems. Parsippany, New Jersey, USA.

Industrial Assessment Centers (IAC). 2015. Industrial Assessment Centers Database. Rutgers University, New Brunswick, New Jersey. Accessed March, 2015. <http://iac.rutgers.edu/database>

InfoMil (2001). Reduction of Nitrous Oxide (N<sub>2</sub>O) in the nitric acid industry. Ministry of housing, spatial planning and the environment. Directorate for climate change and industry. Department of Industry. The Hague, The Netherlands.

Ingersoll Rand, 2001. Air Solutions Group - Compressed Air Systems Energy Reduction Basics. <http://www.air.ingersoll-rand.com/NEW/pedwards.htm>.

Insulcon (unknown date). Wearflex telescopic seals – Flue gas tight seals, to compensate extreme axial movements. Company leaflet.

International Energy Agency (IEA) (2000). Daylight in Buildings: A Sourcebook on Daylighting Systems and Components. Paris, France.

International Energy Agency (IEA) (2007). Tracking Industrial Energy Efficiency and CO<sub>2</sub> Emissions. Paris, France.

International Fertilizers Association (IFA) (2009a). Energy Efficiency and CO<sub>2</sub> Emissions in Ammonia Production, 2008-2009 Summary Report. Paris, France.

International Fertilizers Association (IFA) (2009b). Fertilizers, Climate Change and Enhancing Agricultural Productivity Sustainably. Paris, France.

International Fertilizers Association (IFA) (2013). Fertilizer Indicators. Paris, France.

International Fertilizers Association (IFA) (2014). Ammonia production: moving towards maximum efficiency and lower GHG emissions. Paris, France.

International Fertilizers Association (IFA) (2015). Production and International Trade Statistics. Paris, France. [http://www.fertilizer.org//En/Statistics/PIT\\_Excel\\_Files.aspx](http://www.fertilizer.org//En/Statistics/PIT_Excel_Files.aspx)

IPCC (2006). 2006 IPCC Guidelines for National Greenhouse Gas Inventories. Chapter 3 – Chemical Industry Emissions. [http://www.ipcc-nggip.iges.or.jp/public/2006gl/pdf/3\\_Volume3/V3\\_3\\_Ch3\\_Chemical\\_Industry.pdf](http://www.ipcc-nggip.iges.or.jp/public/2006gl/pdf/3_Volume3/V3_3_Ch3_Chemical_Industry.pdf)

IPTS/EC (2007). Institute for Prospective Technology Studies (IPPC)-Reference Document on Best Available Techniques for the Manufacture of Large Volume Inorganic Chemicals – Ammonia, Acids and Fertilizers. Brussels, Belgium: IPTS/EC; August 2007. [http://eippcb.jrc.ec.europa.eu/reference/BREF/lvic\\_aaf.pdf](http://eippcb.jrc.ec.europa.eu/reference/BREF/lvic_aaf.pdf)

Japan Chemical Industry Association (unknown date). [http://www.energymanagertraining.com/ECDirectory\\_NEDO/11-Chapter3-Section3-Chemical%20Industry-Page137-192.pdf](http://www.energymanagertraining.com/ECDirectory_NEDO/11-Chapter3-Section3-Chemical%20Industry-Page137-192.pdf)

- Johnston, B. (1995). 5 Ways to Greener Steam. *The Chemical Engineer*, 594, pp. 24-27 (August).
- Jones, T. (1997). Steam Partnership: Improving Steam Efficiency Through Marketplace Partnerships. Proc. 1997 ACEEE Summer Study on Energy Efficiency in Industry, ACEEE, Washington DC, USA.
- Joy Industries (1998). Cobalt oxide catalyst. [http://www.joyindustries.com/cobalt\\_oxide.htm](http://www.joyindustries.com/cobalt_oxide.htm)
- Kane, L., Romanow-Garcia, S and Nakamura, D. (1998). Pinch steam trap has not moving parts. *Hydrocarbon Processing*, 77, Issue 1, pp. 33 (January 1998).
- KBR (2009). New KBR ammonia synthesis loop revamp technology improves plant energy efficiency. Nitrogen & Syngas Conference, February 2009, Rome, Italy.  
<http://www.kbr.com/Newsroom/Publications/technical-papers/New-KBR-Ammonia-Synthesis-Loop-Revamp-Technology-Improves-Plant-Energy-Efficiency.pdf>
- Kunjunny, A., Patel, M., Nath, N. (unknown date). Revamping of CO<sub>2</sub> removal section in ammonia plant at IFFCO Kalol.  
[http://www.iffco.nic.in/applications/brihaspat.nsf/0/c5e6f50205333bdb52568420026a6ef/\\$FILE/co2revsp.pdf](http://www.iffco.nic.in/applications/brihaspat.nsf/0/c5e6f50205333bdb52568420026a6ef/$FILE/co2revsp.pdf)
- Lako, P. (2009). Energy conservation potential of the nitrogen fertilizer industry. Rapport ECN-E-09-11, Petten, The Netherlands.
- Lehman, B. and E. Worrell (2001). Electricity Production from Natural Gas Pressure Recovery Using Expansion Turbines. Proceedings 2001 ACEEE Summer Study on Energy Efficiency in Industry, Tarrytown, July 2001.
- Lighting Research Center (LRC) (2001). Lighting Futures: LEDs -- From Indicators to Illuminators? Rensselaer Polytechnic Institute, Troy, New York.
- Linnhoff, B., D.W. Townsend, D. Boland, G.F. Hewitt, B.E.A. Thomas, A.R. Guy, R.H. Marsland (1992). A User Guide on Process Integration for the Efficient Use of Energy (1992 edition), Institution of Chemical Engineers, Rugby, UK.
- Linnhoff, B. (1993). Pinch Analysis: A State-of-the-Art Overview. *Chemical Engineering* 71 (AS): pp.503-522.
- Linnhoff-March (2000). The Methodology and Benefits of Total Site Pinch Analysis. Linnhoff March Energy Services. Paper can be downloaded from:  
<http://www.linnhoffmarch.com/resources/technical.html>
- Malhotra A. and S. Knez (2002). Consider KRES for fuel cost savings and increasing capacity in the ammonia plant. IFA Technical Conference, Chennai 24-27 September 2002, India.
- Malhotra, A., Kramer, P., Singh, S. (2004). Revamp of Liaohe's Ammonia Plant with KRES Technology to Reduce Natural Gas Usage.



Martin, N., M. Ruth, and L. Price, R. N. Elliott, A. M. Shipley, and J. Thorne (2000). "Emerging Energy-Efficient Industrial Technologies," Berkeley: Lawrence Berkeley National Laboratory/Washington, DC: ACEEE.

Maxwell, G. R. (2004). Synthetic nitrogen products: a practical guide to the products and processes. Springer, London, 2004. ISBN-10: 0306482258.

Meessen, J.H. (2010). Urea. In Ullmann's Encyclopedia of Industrial Chemistry. vol. 37, Wiley-VCH Verlag GmbH & Co. KGaA, pp. 657–696.

Motor Decisions Matter (MDM), 2012. Motor Planning Kit. Boston, Massachusetts. <http://www.motorsmatter.org/tools/mpkv22.pdf>

Munch, B., Elholm, P., Stenseng, M. (2007). From Science to Proven Technology – Development of New Topsøe Prereforming catalyst AR-401. Presented at the Nitrogen + Syngas 2007 Conference, Bahrein, 25-28 February 2007.

Nadel, S., M. Shepard, S. Greenberg, G. Katz and A. de Almeida (2002). "Energy Efficient Motor Systems: A Handbook on Technology, Program and Policy Opportunities" ACEEE, Washington, D.C., USA.

Nand, S., Goswami, M. (2009). Energy efficiency gains in Indian ammonia plants – Retrospect and prospects. The Fertilizer Association India, New Delhi, India. Available at: [http://www.emt-india.net/Presentations2009/3L\\_2009Aug24Fertiliser/Material/3-Energy%20Efficiency%20Gains%20in%20Indian%20Ammonia%20Plants%20Retrospects%20and%20Prospects-.pdf](http://www.emt-india.net/Presentations2009/3L_2009Aug24Fertiliser/Material/3-Energy%20Efficiency%20Gains%20in%20Indian%20Ammonia%20Plants%20Retrospects%20and%20Prospects-.pdf)

National Electrical Manufacturers Association (NEMA) (2001). *NEMA Standards Publication No. MG-10 2001, Energy Management Guide For Selection and Use of Fixed Frequency Medium AC Squirrel-Cage Polyphase Induction Motors*. Rosslyn, Virginia.

National Electrical Manufacturers Association (NEMA) (2012). American National Standard – Motors and Generators. American National Standards Institute, Rosslyn, Virginia.

NEDO (2008). Global Warming Counter Measures – Japanese Technologies for Energy Saving/GHG Emission Reduction. New Energy and Industrial Technology Development Organization, 2008 revised edition, Japan.

Oak Ridge National Laboratory (ORNL) (2013). Combined Heat and Power: Enabling Resilient Energy Infrastructure for Critical Facilities, prepared by ICF International.

Oak Ridge National Laboratory (ORNL) (2015). Waste Heat to Power Market Assessment, prepared by ICF International.

Oland, C.B. (2004). Guide to combine heat and power systems for boiler owners and operators, Oak Ridge National Laboratory, Oak Ridge, Tennessee, USA. Available at <http://www1.eere.energy.gov/industry/bestpractices>

OPET Network (1998). A technological breakthrough in radiant efficiency-major fuel saving on a steam reforming furnace, technical fiche for project IN 0031/94/NL. Available at: <http://www.cordis.lu/opet/fiches/rue-5.htm>

Orphanides, P. (2004). Recent developments in urea plant design. ORPHANCO, Greece.

Parekh, P. (2000). "Investment Grade Compressed Air System Audit, Analysis, and Upgrade," In: Proceedings 22nd National Industrial Energy Technology Conference Proceedings. Houston, Texas. April 5-6: pp 270-279.

Parker, S.A., W.D. Hunt, K.M. Fowler, W.F. Sandusky, G.P. Sullivan, B.K. Boyd, K.L.M. Stoughton, T.M. Koehler, R. Pugh. (2015). Metering Best Practices: A Guide to Achieving Utility Resource Efficiency, Release 3.0. Prepared for the United States Department of Energy. Pacific Northwest National Laboratory, Richland, Washington.

Patel, M.R., Shah, C.N., Mehta, B.P.S. (unknown date). Pre-reformer, the solution for increasing plant throughput. IFFCO, India.

Patel, M.R. and N. Nath (2000). Improve Steam Turbine Efficiency. Hydrocarbon Processing, 79, 6 pp.85-90 (June 2000).

PCRA (unknown date). Chapter 10, Fertilizer. <http://www.pkra.org/english/latest/book/10-Chapter%20-%2010.pdf>

Pérez-Ramirez, J., F. Kapteijn, K. Schöffel, and J. A. Moulijn (2003) "Formation and Control of N<sub>2</sub>O in nitric acid production: Where do we stand today?". Applied Catalysis B: Environmental 44 (2003) pp 117-151.

Petryk, J., and Kolakowska, E. (2000). "Cobalt oxide catalysts for ammonia oxidation activated with cerium and lanthanum." Applied catalysis B: Environmental 24 (2000), pp. 121-128

Price, A. and M.H. Ross (1989). Reducing Industrial Electricity Costs – an Automotive Case Study. The Electricity Journal. July, pp. 40-51.

Radgen, P. and E. Blaustein (eds.) (2001). "Compressed Air Systems in the European Union, Energy, Emissions, Savings Potential and Policy Actions,".Fraunhofer Institute for Systems Technology and Innovation, Karlsruhe, Germany.

Ravi, K., Joshi, Y., Dhingra, S., Guha, B. (1989). Simulation of primary and secondary reformers for improved energy performance of an ammonia plant. Chemical Engineering and Technology 12 (5), pp.358-364.

Sadykov, V.A., L.A. Isupova, I.A. Zolotarskii, L.N. Bobrova, A.S. Noskov, V.N. Parmon, E.A. Brushtein, T.V. Telyatnikova, V.I. Chernyshev, and V.V. Lunin (2000). Oxide catalysts for ammonia oxidation in nitric acid production: properties and perspectives. Applied Catalysis A: General 204 (2000) pp. 59-87.

Sakata, E., and Yanagawa, T. (2001). Latest Urea Technology for Improving Performance and Product Quality. Toyo Engineering Corporation, Tokyo, Japan.

Scales, W. and D.M. McCulloch (2007). Best Practices for Compressed Air Systems- Second Edition, Compressed Air Challenge®. Washington, DC. <http://www.compressedairchallenge.org/>

Shenoy, U. (1994). Heat Exchanger Network Synthesis. Gulf Publishing Company, Houston, Texas.

Singh, S., Price, J. (2011). KRES-ES makes more ammonia by energy substitution. Nitrogen+Syngas 309, January-February 2011, pp.59-63. <http://iclib.nipc.net/pubs/new-articles/90-06/En-90-06/820.pdf>

Smith, R. (1995). Chemical Process Design. New York, NY: McGraw-Hill Inc.

Southern California Edison (SCE) (2003). Southern California Edison Educational Publication: Saving Money with Motors in Pharmaceutical Plants. Rosemead, California.

Stamicarbon. (2014). LAUNCH Ultra low energy design. <https://www.stamicarbon.com/ultra-low-energy-concept>

Statbureau (2015). <https://www.statbureau.org/>

Studebaker, P. (2007). 2007 Best Practice Award Winners. Plant Services, February 2007.

Tetley, P. A. (2001). "Cutting Energy Costs with Laboratory Workstation Fume Hood Exhaust." Pharmaceutical Engineering 21 (5): 90–97.

The Fertilizer Institute (TFI), (2005). Ammonia Production Cost Survey. International Center for Soil Fertility and Agricultural Development, Muscle Shoals, AL.

Thyssenkrupp (unknown date). Advanced Process Control for Ammonia Plants. [http://www.uhde-ftp.de/cgi-bin/byteserver.pl/pdf/brochures/services/APC\\_NH3\\_ENG.pdf](http://www.uhde-ftp.de/cgi-bin/byteserver.pl/pdf/brochures/services/APC_NH3_ENG.pdf)

Topsoe (unknown date). R-67-7H Steam Reforming Catalyst. Available at: [http://www.topsoe.com/business\\_areas/hydrogen/~media/PDF%20files/Steam\\_reforming/Topsoe\\_steam\\_reforming\\_cat\\_r%2067%207h.ashx](http://www.topsoe.com/business_areas/hydrogen/~media/PDF%20files/Steam_reforming/Topsoe_steam_reforming_cat_r%2067%207h.ashx)

Tutterow, V., D. Casada, and A. McKane (2000). Profiting from your Pumping System. Proceedings of the 2000 Pump Users Expo, Louisville, Kentucky.

Umicore (2011). Combining competencies for process excellence – Comprehensive platinum based solutions for the chemical industries. Hanau-Wolfgang, Germany.

UNEP (1998). Technical Report in collaboration with UNIDO and the Fertilizer Industry Association. The fertilizer industry's manufacturing processes and environmental issues, report no. 26—part 1. New York: United Nations Publication; 1998. <http://www.fertilizer.org/HomePage/LIBRARY/Our-selection2/Fertilizer-production-technology.html/Mineral-Fertilizer-Production-and-the-Environment.-Part-1.-The-Fertilizer-Industry-s-Manufacturing-Processes-and-Environmental-Issues.html>

UNFCCC (2008). Monitoring report – reduction in steam consumption through revamping of ammonia plant of IFFCO plants.

<http://cdm.unfccc.int/filestorage/Y/4/D/Y4DVQTHIIIWA650LM6VB62IUFMVK2N/Monitoring%20Report%201.pdf?t=bll8bWpwZWszfDDfOuM5C5Upy34eXtiZc-kl>

Ullmann's (2011). "Ullmann's Encyclopedia for Industrial Chemistry". Volume 3.

United Nations Industrial Development Organization (UNIDO) (1979). Fertilizer Manual. Kluwer Academic Publishers, the Netherlands.

United States Department of Agriculture (USDA) (2013). Fertilizer Use and Price. Fertilizer Consumption and Use by Year. Economic Research Service (ERS). <http://www.ers.usda.gov/data-products/fertilizer-use-and-price.aspx>

United States Department of Energy (DOE) (2001a). Pump Life Cycle Costs: A Guide to LCC Analysis for Pumping Systems. Office of Energy Efficiency and Renewable Energy, Industrial Technologies Program, Washington, D.C. Report DOE/GO-102001-1190

United States Department of Energy (DOE) (2001b) Steam Cost Reduction Strategies; Reducing your steam system energy bill. U.S. Department of Energy, Washington, DC, USA. Downloaded from <http://www1.eere.energy.gov/industry/>

United States Department of Energy (DOE) (2002). United States Industrial Electric Motor Systems Market Opportunities Assessment. Office of Industrial Technologies, Washington, D.C.

United States Department of Energy (DOE) (2003a). 3M: Hutchinson Plant Focuses on Heat Recovery and Cogeneration during Plant-Wide Energy efficiency Assessment. June 2003. Office of Industrial Technologies, U.S. Department of Energy, Washington, DC, USA. Downloaded from <http://www1.eere.energy.gov/industry/>

United States Department of Energy (DOE) (2003b). Improving Fan System Performance. A sourcebook for industry. Office of Energy Efficiency and Renewable Energy, Industrial Technologies Program, Washington, D.C. DOE/GO-102003-1824.

United States Department of Energy (DOE) (2004a). Energy Tips – Compressed Air: Remove Condensate with Minimal Air Loss. Office of Energy Efficiency and Renewable Energy, Industrial Technologies Program, Washington, D.C. Compressed Air Tip Sheet #13.

United States Department of Energy (DOE) (2004b). Energy Tips – Compressed Air: Eliminate Inappropriate Uses of Compressed Air. Office of Energy Efficiency and Renewable Energy, Industrial Technologies Program, Washington, D.C. Compressed Air Tip Sheet #2.

United States Department of Energy (DOE) (2004c). Energy Tips – Compressed Air: Alternative Strategies for Low-Pressure End Uses. Office of Energy Efficiency and Renewable Energy, Industrial Technologies Program, Washington, D.C. Compressed Air Tip Sheet #11.

United States Department of Energy (DOE) (2005a). Energy Tips – Motor Systems. Eliminate Voltage Unbalance. Office of Energy Efficiency and Renewable Energy, Industrial Technologies Program, Washington, D.C. DOE/GO-102005-2061.

United States Department of Energy (DOE) (2005b). Steam Pressure Reduction: Opportunities and Issues. Office of Energy Efficiency and Renewable Energy, Industrial Technologies Program, Washington, D.C. USA.

United States Department of Energy (DOE) (2006a). Improving Pumping System Performance. A Sourcebook for Industry. Office of Energy Efficiency and Renewable Energy, Industrial Technologies Program, Washington, D.C. DOE/GO-102006-2079.

United States Department of Energy (DOE) (2006b). Steam Tip Sheets. Industrial technologies Program, Office of Industrial Technologies, U.S. Department of Energy, Washington, DC, USA. Downloaded from <http://www1.eere.energy.gov/industry/bestpractices>

United States Department of Energy (U.S. DOE) (2007a) Steam Tip Sheets, August 2007. Industrial technologies Program, Office of Industrial Technologies U.S. Department of Energy, Washington, DC, USA. Downloaded from <http://www1.eere.energy.gov/industry/bestpractices>

United States Department of Energy (U.S. DOE) (2007b). Terra Nitrogen Company, L.P.: Ammonia Plant Greatly Reduces Natural Gas Consumption After Energy Assessment. Save Energy Now, October, 2007. [http://www1.eere.energy.gov/manufacturing/tech\\_deployment/pdfs/42010.pdf](http://www1.eere.energy.gov/manufacturing/tech_deployment/pdfs/42010.pdf)

United States Department of Energy, Energy Efficiency and Renewable Energy (DOE) (2008a). Improving Motor and Systems Performance: A Sourcebook for Industry. Office of Energy Efficiency and Renewable Energy, Washington, D.C.

United States Department of Energy, Energy Efficiency and Renewable Energy (DOE) (2008b). Improving process heating system performance: A sourcebook for industry. U.S. Department of Energy, Energy Efficiency and Renewable Energy. <http://www.nrel.gov/docs/fy08osti/41589.pdf>

United States Department of Energy, Energy Efficiency and Renewable Energy (DOE) (2012). Improving steam system performance: A sourcebook for industry. Second Edition. U.S. Department of Energy, Energy Efficiency and Renewable Energy. <http://invenoinc.com/file/Improving-Steam-System-Performance-Sourcebook-for-Industry.pdf>

United States Department of Energy (DOE) (2016). CHP Installation Database, December 2016, <https://doe.icfwebservices.com/chpdb/>

United States Department of Energy (DOE) and Compressed Air Challenge (CAC) (2003). Improving Compressed Air System Performance - A Sourcebook for Industry. Office of Industrial Technologies, Washington, D.C.

United States Energy Information Administration (EIA) (2012). Combined heat and power technology fills an important energy niche. October 2012 <http://www.eia.gov/todayinenergy/detail.php?id=8250>

United States Economic Census (2014). Manufacturing: Industry Series: Detailed Statistics by Industry for the U.S.: 2012. <http://factfinder.census.gov/faces/nav/jsf/pages/index.xhtml>

United States Environmental Protection Agency (U.S. EPA) (2006). *Teaming Up to Save Energy - Protect Our Environment Through Energy Efficiency*. Prepared by ICF International. Washington, D.C.

United States Environmental Protection Agency (U.S. EPA) (2008). ENERGY STAR Building Upgrade Manual (2008 Edition). Office of Air and Radiation. Washington, D.C. Download from: [www.energystar.gov/index.cfm?c=business.bus\\_upgrade\\_manual](http://www.energystar.gov/index.cfm?c=business.bus_upgrade_manual).

United States Environmental Protection Agency (U.S. EPA) (2009). Technical Support Document for the Nitric Acid Production Sector: Proposed Rule for Mandatory Reporting of Greenhouse Gases. Office of Air and Radiation.

United States Environmental Protection Agency (U.S. EPA) (2010). Available and Emerging Technologies for Reducing Greenhouse Gas Emissions from the Nitric Acid Production Industry. Sector Policies and Programs Division, Office of Air Quality Planning and Standards, North Carolina.

United States Environmental Protection Agency (U.S. EPA) (2012). Waste Heat to Power Systems, May 2012.

United States Environmental Protection Agency (U.S. EPA) (2015). Catalog of CHP Technologies, March 2015.

United States Geological Survey (USGS) (2004). Mineral Commodity Profiles – Nitrogen. <http://minerals.usgs.gov/minerals/pubs/commodity/mcp.html>

United States Geological Survey (USGS) (2012). 2011 Minerals Yearbook – Nitrogen [advance release]. Washington, D.C., USGS, <http://minerals.er.usgs.gov/minerals/>

United States Geological Survey (USGS) (2015a). 2013 Minerals Yearbook – Nitrogen [advance release]. Washington, D.C., USGS, <http://minerals.er.usgs.gov/minerals/>

United States Geological Survey (USGS) (2015b). Nitrogen (fixed)—ammonia statistics, *in* Kelly, T.D., and Matos, G.R., comps., Historical statistics for mineral and material commodities in the United States: U.S. Geological Survey Data Series 140 <http://minerals.usgs.gov/minerals/pubs/historical-statistics/>.

United States Geological Survey (USGS) (various years). Minerals Yearbook – Nitrogen [advance release]. Washington, D.C., USGS, <http://minerals.er.usgs.gov/minerals/>

Vaish, V.S. and Patel, M.R. (2002). Stretching the capacity of a 23-year old Kellogg ammonia plant. IFA Technical Conference, Chennai India, 24-27 September 2002.

Van de Ruit, H. (2000). Improve Condensate Recovery Systems. Hydrocarbon Processing, 12, 79 pp.47-53 (December 2000).

Verduijn, W.D., de Wit, J.J. (2001). Energy conservation: key to survival for fertiliser producers. Paper presented to “The international fertiliser society”, London, 10 May 2001.

Wiesenberger, H. (2001). State-of-the-art for the production of nitric acid with regard to the IPPC directive. Federal Environment Agency – Austria.

Worrell, E. and Blok, K. (1994). Energy Savings in the Nitrogen Fertilizer Industry in the Netherlands. Energy, vol. 19, pp.195-209.

Worrell, E., J.W. Bode, J.G. de Beer (1997). "Energy Efficient Technologies in Industry - Analyzing Research and Technology Development Strategies - The 'Atlas' Project", Dept. of Science, Technology & Society, Utrecht University, Utrecht, The Netherlands.

Worrell, E. and C. Galitsky (2005). Energy Efficiency Improvement and Cost Saving Opportunities for Petroleum Refineries: An ENERGY STAR Guide for Energy and Plant Managers. Lawrence Berkeley National Laboratory, Berkeley, California. Report LBNL-56183.

[http://www.energystar.gov/ia/business/industry/ES\\_Petroleum\\_Energy\\_Guide.pdf](http://www.energystar.gov/ia/business/industry/ES_Petroleum_Energy_Guide.pdf)

Worrell, E., Philipsen D., Einstein, D. And Martin, N. (2000). Energy Use and Energy intensity of the U.S. Chemical Industry. Lawrence Berkley National Laboratory, Berkeley, CA

[http://www.energystar.gov/ia/business/industry/industrial\\_LBNL-44314.pdf](http://www.energystar.gov/ia/business/industry/industrial_LBNL-44314.pdf)

Xenergy, Inc. (1998). United States Industrial Electric Motor Systems Market Opportunities Assessment. U.S. Department of Energy's Office of Industrial Technology and Oak Ridge National Laboratory.

[http://www1.eere.energy.gov/manufacturing/tech\\_assistance/pdfs/mtrmkt.pdf](http://www1.eere.energy.gov/manufacturing/tech_assistance/pdfs/mtrmkt.pdf)

Yara (2009). Yara N<sub>2</sub>O abatement experiences. Presentation Yara catalyst department.

Zardi, F. (2010). Latest application of Casale technologies to urea plants. Prepared for presentation at the Nitrogen & Syngas conference and exhibition. 28<sup>th</sup> February- 3<sup>rd</sup> March, 2010. Bahrain.